

General Instruments

Wound and Nerve Hooks Crochets des plaies et du nerf
 Wund-und Nerven-Hooks De la herida y los nervios Ganchos

MEDSIGN INSTRUMENTS



Sharp
scharf
net
agudo
MSI-8055-01

blunt
stumpf
émousser
embotar
MSI-8055-02

Miller
13.5cm/5 1/4"



Crile
MSI-8056-20
20cm/8"



Cushing

19cm/7 1/2"
28cm/11"



Fig. 1

MSI-8057-19
MSI-8057-28



Fig. 2

MSI-8058-19
MSI-8058-28



Kilner
MSI-8059-15
15cm/6"



Fig.1

Gillies
MSI-806018
18cm/7"



Fig.2

Gillies
MSI-8061-18
18cm/7"



Sharp
scharf
net
agudo



blunt
stumpf
émousser
embotar

Frazier
MSI-8062-13 13cm/5" MSI-8063-13
MSI-8062-18 18cm/7" MSI-8063-18

General Instruments

Wound and Nerve Hooks
Wund-und Nerven-Hooks

Crochets des plaies et du nerf
De la herida y los nervios Ganchos

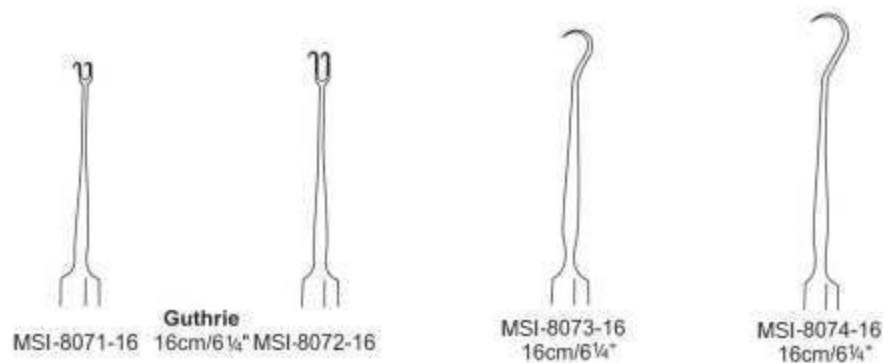
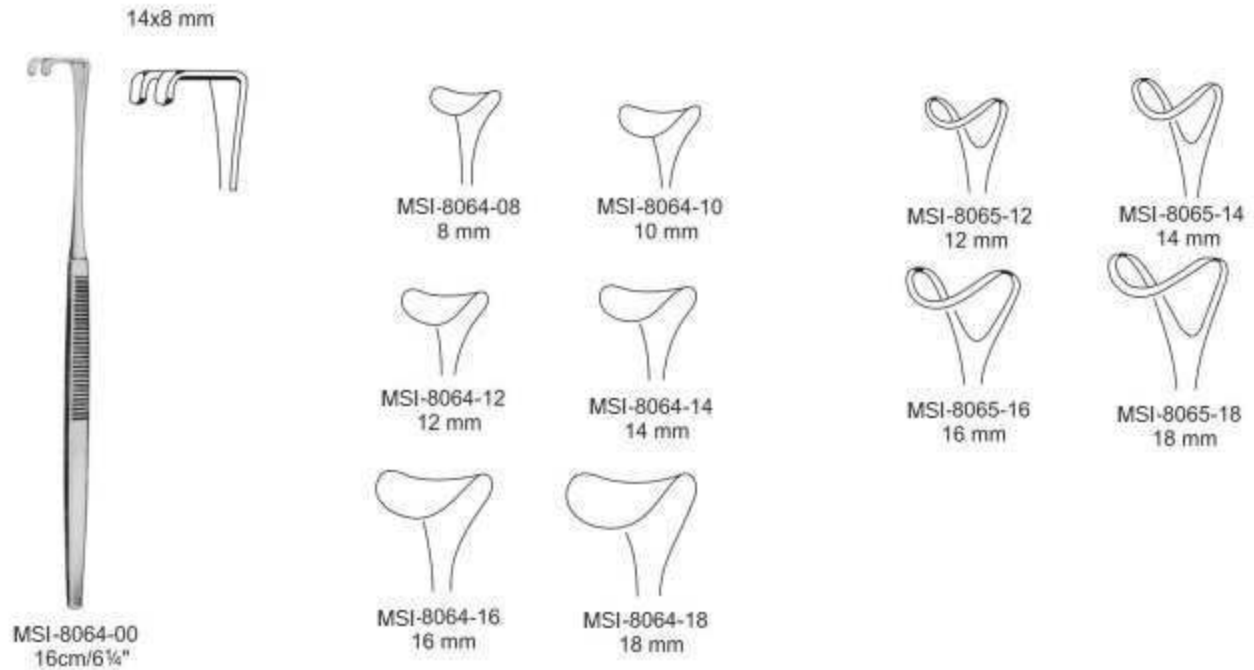

General Instruments

Wound and Trachea Retractors Rétracteurs plaies et de la trachée
 Wund-und Luftröhre Retraktoren Heridas y tráquea Retractores

MEDSIGN INSTRUMENTS

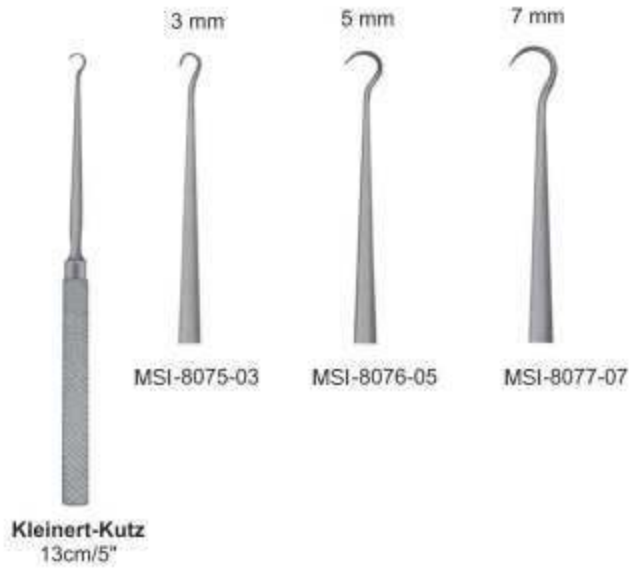

General Instruments

Retractors
Retraktoren

Rétracteurs
Retradores

Malleable
formbar
malleable
maleable



Gil-Vernet
24cm/9½"

8 mm	MSI-8083-08	MSI-8084-08
11 mm	MSI-8083-11	MSI-8084-11
15 mm	MSI-8083-15	MSI-8084-15
17 mm	MSI-8083-17	MSI-8084-17
20 mm	MSI-8083-20	MSI-8084-20
23 mm	MSI-8083-23	MSI-8084-23

Malleable
formbar
malleable
maleable



24cm/9½"

12x14 mm



Little
MSI-8085-20
20cm/8"



Love-(Morse)
25cm/10"

10 mm	MSI-8086-10
15 mm	MSI-8086-15
20 mm	MSI-8086-20
30 mm	MSI-8086-30
40 mm	MSI-8086-40
50 mm	MSI-8086-50

General Instruments

Wound and Trachea Retractors
Wund- und Luftröhre Retraktoren

Rétracteurs plaies et de la trachée
Heridas y tráquea Retractores

MEDSIGN INSTRUMENTS

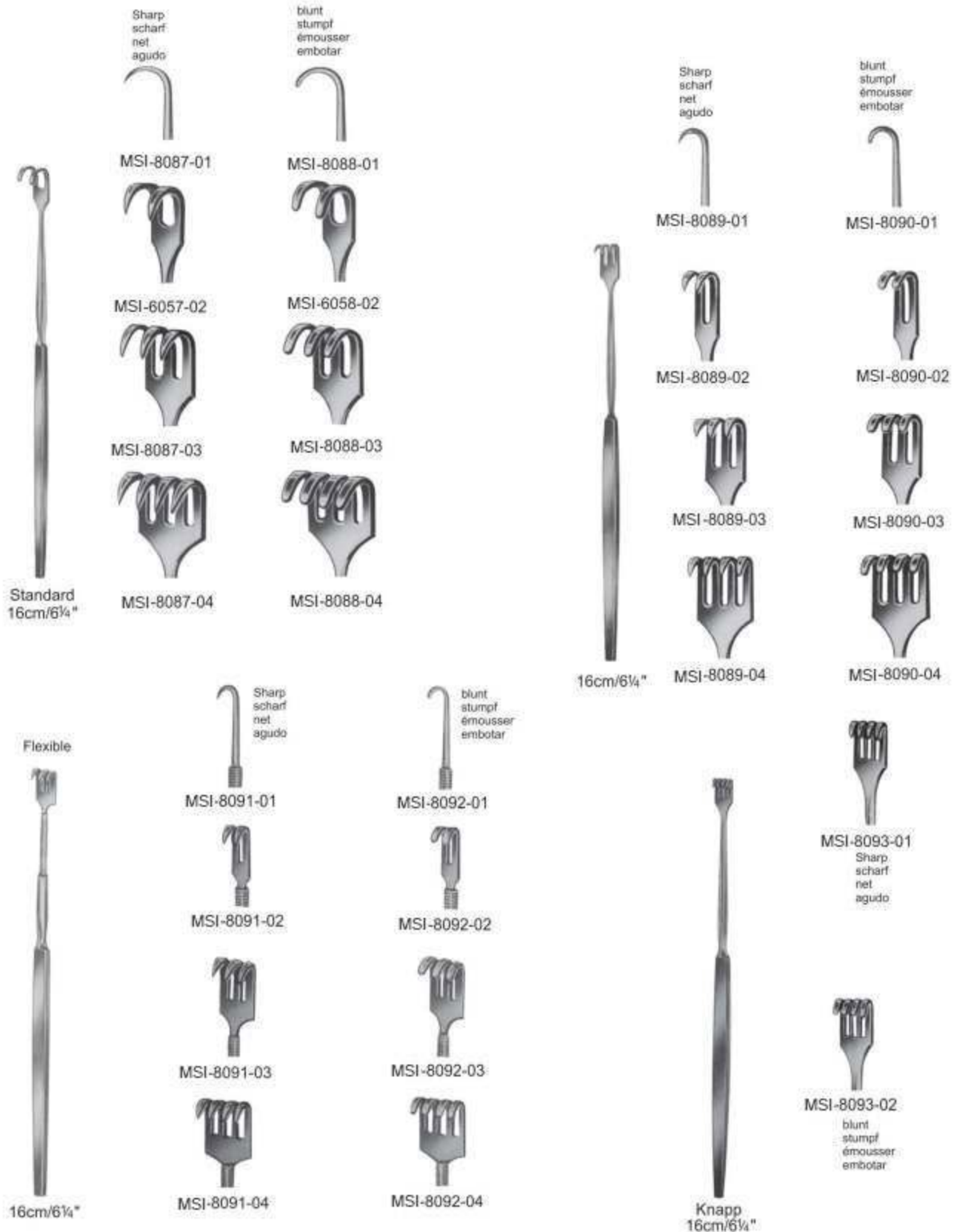

General Instruments

Trachea Retractors
Trachea Retraktoren

Rétracteurs trachée
tráquea Retractores



MSI-8094-13
13.5m/5¼"



Jackson
MSI-8095-13
13cm/5"



Bergmann
MSI-8096-14
14cm/5½"



Iterson
16cm/6¼"



MSI-8097-16



MSI-8097-16



Meyerding
18cm/7"



MSI-8098-18
18x7 mm



MSI-8101-18
16x5 mm



MSI-8099-18
7x4 mm



MSI-8102-18
10x3 mm



MSI-8100-18
7x4 mm



MSI-8103-18



Volkman
11.5cm/4½"



MSI-8104-02



MSI-8105-02



MSI-8104-03



MSI-8105-03



MSI-8104-04



MSI-8105-04



MSI-8104-06



MSI-8105-06

General Instruments

Wound and Vein Retractors Rétracteurs plaies et de la veine
Wund-und Vein Retraktoren Heridas y Vena Retractores

MEDSIGN INSTRUMENTS

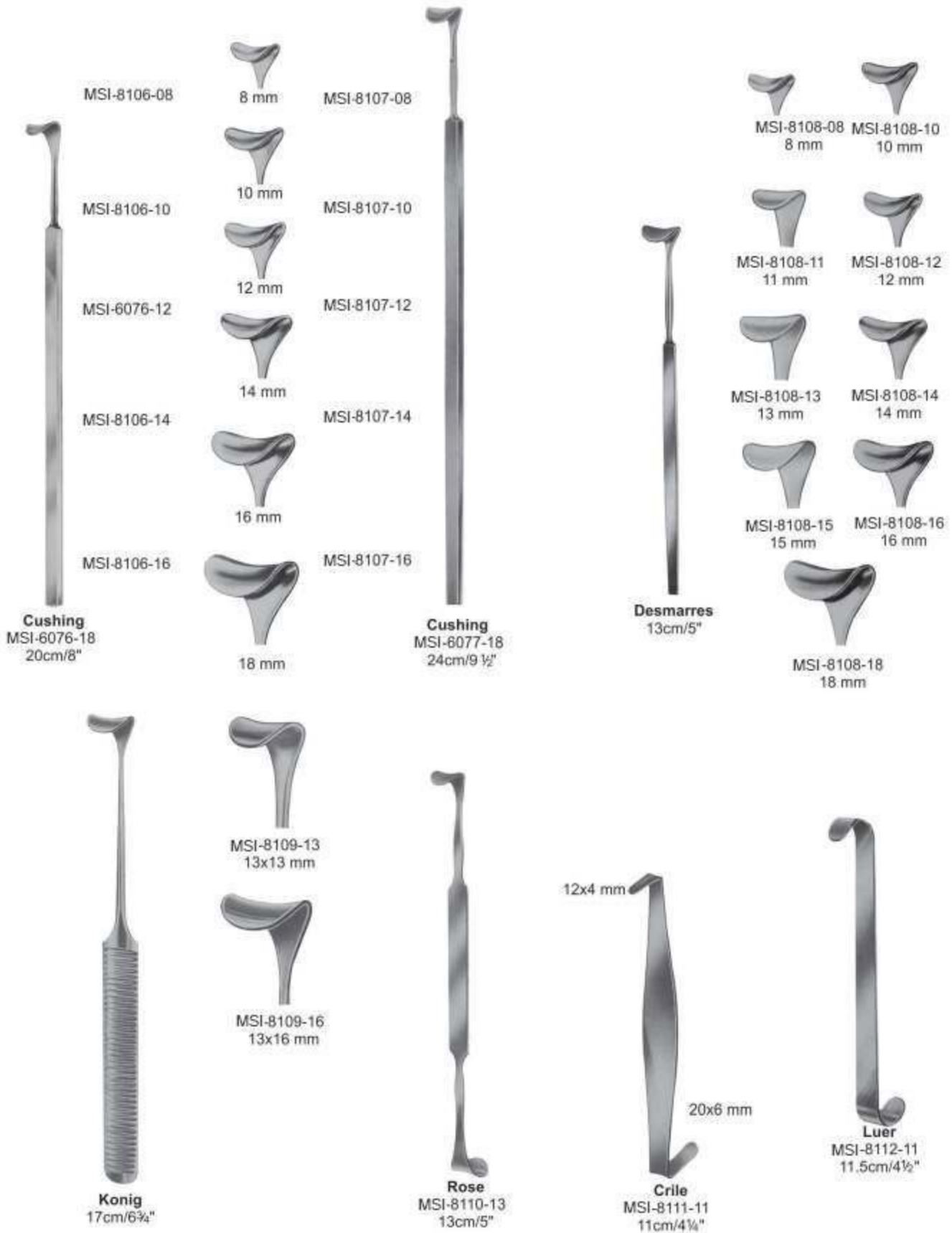

General Instruments

Retractors
Retraktoren

Rétracteurs
Retradores

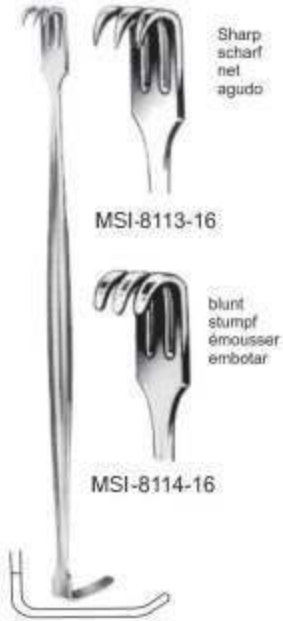

Senn-Miller
16cm/6¼"

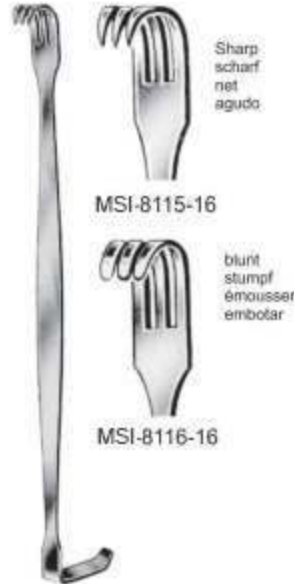

Baby-Senn-Miller
16cm/6¼"



Rangell-Davis
MSI-8117-14
14cm/5½"



Senn-Green
15cm/6"



Langenbeck-Green
16cm/6¼"

General Instruments

Retractors and Tendon Sheath Hooks Rétracteurs et Crochets gainé du tendon
 Retraktoren und Sehnenscheide Haken Los retractores y ganchos la vaina del tendón

MEDSIGN INSTRUMENTS



Cushing-Kocher
 MSI-8122-18
 18cm/7"

10x10 mm



Langenbeck-Green
 17cm/6¾"

MSI-8123-17
 6x25 mm

MSI-8124-17
 8x25 mm



Strandell-Stille
 19cm/7½"

Tendon Sheath Hook
 Sehnenscheide Haken
 Crochet gainé du tendon
 Hook vaina del tendón

MSI-8125-19

MSI-8126-19

Tendon Sheath Hook
 Sehnenscheide Haken
 Crochet gainé du tendon
 Hook vaina del tendón



Klapp
 17.5 cm/7"

MSI-8127-01



MSI-8127-02



MSI-8127-03



Decompression Hook
 Décompression Haken
 Crochet de décompression
 descompresión Hook

Cushing
 MSI-8128-20
 20cm/8"

General Instruments

Retractors
Rétracteurs
Retraktoren

Rétracteurs
Retractors



Collin-Hartmann

Set	MSI-8129-00
14 cm/5½"	MSI-8129-01
16 cm/6"	MSI-8129-02



Roux

Set	MSI-8130-00
14 cm/5½" Fig. 1	MSI-8130-01
15 cm/6" Fig. 2	MSI-8130-02
17 cm/6¾" Fig. 3	MSI-8130-03



Baby-Roux
13 cm/5"



Mini-Roux
14 cm/5½"

MSI-8131-13	MSI-8132-14
-------------	-------------

37x40 mm



37x31 mm

Goelet
MSI-8133-19
19 cm/7½"



Parker-Langenbeck (US-Army)
MSI-8134-21
21cm/8¼"

Set
setzen
fixer
establecer



Parker
MSI-8135-13
13.5 cm/5¼"

Set
setzen
fixer
establecer



Parker
MSI-8136-18
18 cm/7"

Set
setzen
fixer
establecer



Parker-Mott
MSI-8137-16
16 cm/6¼"

Set
setzen
fixer
establecer



Farabeuf
MSI-8138-12
12 cm/4¾"

Set
setzen
fixer
establecer



Farabeuf
MSI-8139-15
15 cm/6"

Set
setzen
fixer
establecer



Farabeuf
MSI-8140-01
8x10x100mm
MSI-8140-02
7x9x120mm
MSI-8140-03
11x14x120mm
MSI-8140-04
11x15x150mm
MSI-8140-05
21x15x150mm



Collin
MSI-8141-16
16.5 cm/6½"

Set
setzen
fixer
establecer



Mayo-Collin
MSI-8142-15
15 cm/6"

Set
setzen
fixer
establecer



Mathieu
MSI-8143-19
19 cm/7½"

Set
setzen
fixer
establecer

General Instruments

Retractors and Bone Retractors Rétracteurs et écarteurs à os
 Retraktoren und Bone Retraktoren Separadores y Retractores hueso



Sharp
scharf
net
agudo

Volkmann
MSI-8143-22
22 cm/8 3/4"



blunt
stumpf
émousser
embotar

Volkmann
MSI-8144-22
22 cm/8 3/4"



Sharp
scharf
net
agudo

MSI-8145-23
23 cm/9"



blunt
stumpf
émousser
embotar

MSI-8146-23
23 cm/9"



Volkmann
21,5cm/8 1/2"



Sharp
scharf
net
agudo

MSI-8147-01



MSI-8147-02



MSI-8147-03



MSI-8147-04



MSI-8147-06



MSI-8147-08

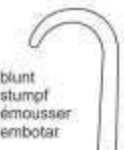

blunt
stumpf
émousser
embotar

MSI-8148-01



MSI-8148-02



MSI-8148-03



MSI-8148-04



MSI-8148-06



MSI-8148-08



semi-sharp
semi-scharfe
semi-forte
semi-fuerte

MSI-8149-01



MSI-8149-02



MSI-8149-03



MSI-8149-04



MSI-8149-06



MSI-8149-08

General Instruments

Retractors and Bone Retractors Rétracteurs et écarteurs à os
 Retraktoren und Bone Retraktoren Separadores y Retractores hueso

MEDSIGN INSTRUMENTS



Volkman
21 cm/8³/₄"



Sharp
scharf
net
agudo

MSI-8150-01



MSI-8150-02



MSI-8150-03



MSI-8150-04



MSI-8150-06



blunt
stumpf
émousser
embotar

MSI-8151-01



MSI-8151-02



MSI-8151-03



MSI-8151-04



MSI-8151-06



semi-sharp
semi-scharfe
semi-forte
semi-fuerte

MSI-8152-01



MSI-8152-02



MSI-8152-03



MSI-8152-04



MSI-8152-06



Sharp
scharf
net
agudo

MSI-8153-24
24.5 cm/9³/₄"



Sharp
scharf
net
agudo

Kocher
MSI-8154-21
21.5 cm/8¹/₂"



blunt
stumpf
émousser
embotar

Kocher
MSI-8155-21
21.5 cm/8¹/₂"



Sharp
scharf
net
agudo

Kocher
MSI-8156-21
21.5 cm/8¹/₂"



blunt
stumpf
émousser
embotar

Kocher
MSI-8157-21
21.5 cm/8¹/₂"

General Instruments

Retractors and Bone Retractors Rétracteurs et écarteurs à os
 Retraktoren und Bone Retraktoren Separadores y Retractores hueso



Kocher
22 cm/8¾"

Sharp
scharf
net
agudo



MSI-8158-01



MSI-8158-02



MSI-8158-03



MSI-8158-04



MSI-8158-06



MSI-8158-08

blunt
stumpf
émousser
embotar



MSI-8159-01



MSI-8159-02



MSI-8159-03



MSI-8159-04



MSI-8159-06



MSI-8159-08

semi-sharp
semi-scharf
semi-forte
semi-fuerte



MSI-8160-01



MSI-8160-02



MSI-8160-03



MSI-8160-04



MSI-8160-06



MSI-8160-08



Sharp
scharf
net
agudo

MSI-8161-20
20 cm/8"



blunt
stumpf
émousser
embotar

MSI-8162-20
20 cm/8"



Sharp
scharf
net
agudo

MSI-8163-14
14 cm/5½"

General Instruments

Retractors
Retraktoren

Rétracteurs
Retractorés



Ollier
MSI-8165-02
36x60 mm
22,5 cm/9"

Ollier
MSI-8164-01
36x30 mm
22,5 cm/9"



Murphy
19.5 cm/7 3/4"

Sharp
scharf
net
agudo



MSI-81636-02



MSI-8166-03



MSI-8166-04



MSI-8166-06

blunt
stumpf
émousser
embotar



MSI-8167-02



MSI-8167-03



MSI-8167-04



U6-8167-06

General Instruments

Retractors
Retraktoren

Rétracteurs
Retradores



33x20 mm

Wassmund
MSI-8168-20
20cm/8"



46x55 mm

Koerte
23cm/9"

Vertical Handle
vertikale Griff
poignée verticale
asa vertical
MSI-8170-23



MSI-6139-02
40x50 mm

Israel
25cm/10"



MSI-8169-01
40x40 mm



MSI-8169-03
50x60 mm



MSI-8169-04
70x70 mm

General Instruments

Retractors
Retraktoren

Rétracteurs
Retradores



Koerte-Wagner
MSI-8171-28
28cm/11"



Koerte
23.5 cm/9¼"

Vertical Handle
vertikale Griff
poignée verticale
asa vertical

40x30 mm



Sharp
scharf
net
agudo
MSI-8172-23

blunt
stumpf
émousser
embotar
MSI-8173-23



MSI-8174-24
24cm/9½"

Vertical Handle
vertikale Griff
poignée verticale
asa vertical

50x25 mm



MSI-8175-25
25cm/10"

General Instruments

Retractors
Retraktoren

Rétracteurs
Retractoros



Langenbeck

MSI-8176-01 22x6mm 21.5cm/8 1/4"
MSI-8176-02 44x13mm 21.5cm/8 1/4"
MSI-8176-03 64x25mm 21.5cm/8 1/4"



Langenbeck
21cm/8 1/4"

MSI-8177-01
55x20 mm
MSI-8177-02
60x20 mm
MSI-8177-03
63x20 mm



Langenbeck
21cm/8 1/4"

MSI-8178-01
35x7 mm
MSI-8178-02
35x10 mm
MSI-8178-03
35x15 mm
MSI-8178-04
60x20 mm



Lahey
19cm/7 1/2"

MSI-8179-19
28x6 mm



22.5cm

Sauerbruch

MSI-8180-01 45x15 mm
MSI-8180-02 60x23 mm
MSI-8180-03 75x20 mm



Langenbeck
21cm/8 1/4"

MSI-8181-01 30x11 mm
MSI-8181-02 30x14 mm
MSI-8181-03 33x14 mm
MSI-8181-04 30x16 mm
MSI-8181-05 40x11 mm
MSI-8181-06 42x13 mm
MSI-8181-07 50x11 mm

MSI-8181-08
MSI-8181-09
MSI-8181-10
MSI-8181-11
MSI-8181-12



Langenbeck
22cm/8 3/4"

MSI-8182-01 40x10 mm
MSI-8182-02 40x15 mm
MSI-8182-03 40x20 mm



Kocher
22cm/8¾"

MSI-8183-01
19x12 mm
MSI-8183-02
21x15 mm



Kocher
19cm/7½"

MSI-8184-01 25x06 mm
MSI-8184-02 25x08 mm
MSI-8184-03 35x08 mm
MSI-8184-04 35x11 mm
MSI-8184-05 35x15 mm
MSI-8184-06 42x11 mm
MSI-8184-07 55x11 mm
MSI-8184-08 70x14 mm
MSI-8184-09 80x12 mm
MSI-8184-10 80x16 mm



Kocher-Langenbeck
21.5cm/8½"



Czerny
MSI-8185-18
18 cm/7"



67x17cm

Casper
MSI-8186-21
21.5cm/8½"

General Instruments

Retractors
Retraktoren

Rétracteurs
Retradores



MSI-8187-03
67x25 mm



MSI-8187-04
100x35 mm



MSI-8187-01
22x15 mm



MSI-8187-02
38x20 mm



MSI-8188-01
40x18 mm
MSI-8188-02
60x20 mm
MSI-8188-03
60x25 mm
MSI-8188-04
75x30 mm
MSI-8188-05
75x40 mm

Kocher
23cm/9"

Kocher-Wagner
28cm/11"



MSI-8189-01
60x20 mm
MSI-8189-02
80x30 mm
MSI-8189-03
100x30 mm
MSI-8189-04
120x30 mm
MSI-8189-05
140x30 mm
MSI-8189-06
140x40 mm

Heosel
25cm/10"



130x60 mm

St. Marks
MSI-8191-29
29cm/11½"

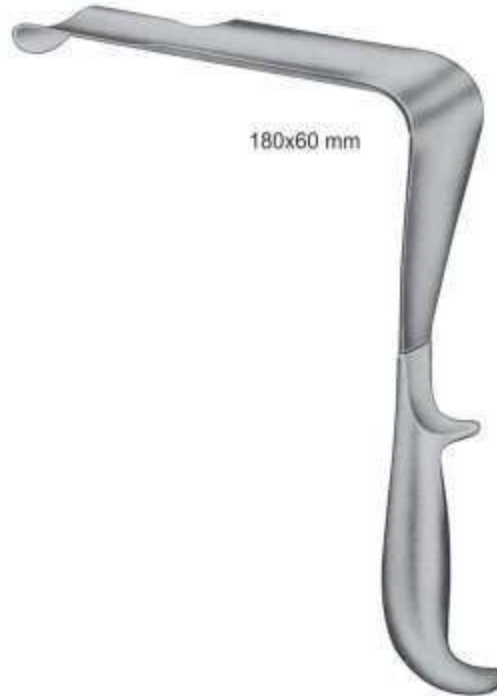

180x60 mm

St. Marks
MSI-8192-32
32.5cm/12¾"



180x60 mm

St. Marks
MSI-8193-33
33cm/13"



MSI-8194-01
70x40 mm
MSI-8194-02
70x50 mm
MSI-8194-03
70x65 mm

Morris
21cm/8¼"



MSI-8195-01
32x50 mm/38x50mm
MSI-8195-02
45x50 mm/50x50mm
MSI-8195-03
65x50 mm/38x50mm

Morris
24cm/9½"

General Instruments

Retractors and Meniscus Retractors Rétracteurs Rétracteurs et méniscales
 Retraktoren und Meniskus Retraktoren Separadores y Retractores de menisco



38x9 mm

Meniscus Retractors
 Ecarteurs ménisque
 Retractores de menisco

MSI-8196-21
 21cm/8¼"



40x5 mm

Blunt
 MSI-8197-18
 18cm/7"



Crawford
 19cm/7½"



MSI-8198-01
 15x15 mm

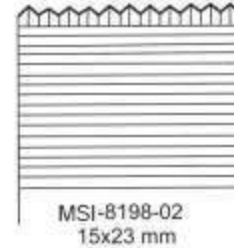

MSI-8198-02
 15x23 mm



Green
 MSI-8199-22
 22cm/8½"



Middeldorpf

MSI-8200-01



14x17 mm
 21.5cm/8½"

MSI-8201-01

MSI-8200-02



20x22 mm
 22cm/8¾"

MSI-8201-02

MSI-8200-03



26x30 mm
 23.5cm/9¼"

MSI-8201-03



Middeldorpf

General Instruments

Retractors
Retraktoren

Rétracteurs
Retractoros



Middeldorpf
25.5cm/10"

MSI-8202-01
45x45 mm
MSI-8202-02
45x50 mm
MSI-8202-03
55x70 mm



Richardson
26cm/10¼"



Richardson-Eastman
Set
setzen U6-8204-00
fixer
establecer

Fig. 1
26cm/10¼" MSI-8204-01

Fig. 2
28cm/11" MSI-8204-02



Kelly
26cm/10¼"

MSI-8205-01
40x50 mm
MSI-8205-02
50x65 mm
MSI-8205-03
65x75 mm
MSI-8205-04
75x90 mm

General Instruments

Retractors
Retraktoren

Rétracteurs
Retractoros



General Instruments

Retractors
Retraktoren

Rétracteurs
Retradores



- MSI-8210-01
40x40 mm
- MSI-8210-02
45x40 mm
- MSI-8210-03
45x50 mm
- MSI-8210-04
45x60 mm
- MSI-8210-05
45x75 mm
- MSI-8210-06
65x85 mm

Fritsch
24cm/9½"



50x85 mm

Doyen
MSI-8211-25
25cm/10"



- MSI-8212-01
15x90 mm
- MSI-8212-02
20x90 mm
- MSI-8212-03
30x90 mm
- MSI-8212-04
35x110 mm
- MSI-8212-05
40x110 mm
- MSI-8212-06
55x120 mm

Doyen-Stille
24cm/9½"



70x25 mm

Kocher
MSI-8213-22
22.5cm/9"



- MSI-8214-01
80x45 mm
- MSI-8214-02
80x55 mm
- MSI-8214-03
80x65 mm

Kocher
25cm/10"



64x60 mm

Tuffier
MSI-8215-23
23cm/9"



- MSI-8216-01
115x22 mm
- MSI-8216-02
115x27 mm

Simon
28cm/11"

General Instruments

Retractors and Liver Retractors Rétracteurs Rétracteurs et du foie
Retraktoren und Leber Retraktoren Separadores y Retractores hepáticos



95x20 mm

Tuebingen
MSI-8217-28
28cm/11"



105x27 mm

Martin
MSI-8218-26
26cm/10¼"

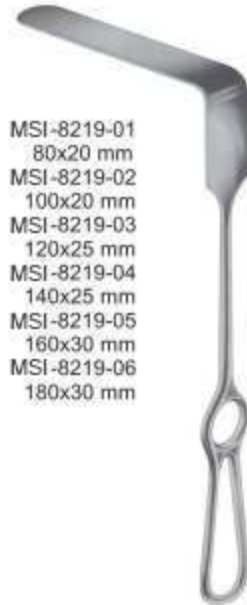

MSI-8219-01
80x20 mm
MSI-8219-02
100x20 mm
MSI-8219-03
120x25 mm
MSI-8219-04
140x25 mm
MSI-8219-05
160x30 mm
MSI-8219-06
180x30 mm

Brunner
25cm/10"



MSI-8220-01
80x20 mm
MSI-8220-02
100x20 mm
MSI-8220-03
120x25 mm
MSI-8220-04
140x25 mm
MSI-8220-05
160x30 mm
MSI-8220-06
180x30 mm

Brunner
25cm/10"



90x50 mm

MSI-8221-01
95x35 mm
MSI-8221-02
120x50 mm
MSI-8221-03
155x50 mm

Mikulicz
26cm/10¼"



90x50 mm

Mikulicz
MSI-8222-26
26cm/10¼"



MSI-8223-01
160x38 mm
MSI-8223-02
160x57 mm
MSI-8223-01
190x38 mm
MSI-8223-02
190x57 mm

Kelly
27cm/10½"



Polloson
MSI-8224-27
27cm/10½"



Polloson
MSI-8225-27
27cm/10½"



MSI-8226-03
115x65 mm

MSI-8226-02
108x43 mm

MSI-8226-01
82x22 mm

Coryllos
23.0cm/9"



MSI-8227-25
125x37 mm

Sauerbruch
25cm/10"

General Instruments

Retractors and Lung Spatulas Rétracteurs Spatules et du poumon
 Retraktoren und Lungenforschung Spatel Los retractores y espátulas de pulmón



Deaver
MSI-8228-01
18 cm/7"



Deaver
MSI-8229-02
21.5 cm/8½"



Deaver
MSI-8230-03
23 cm/9"



Deaver
MSI-8231-04 30cm/12"
MSI-8231-05 33cm/13"
MSI-8231-06 36cm/14"



Deaver
30 cm/12"

MSI-8232-07
38 mm
MSI-8232-08
50 mm
MSI-8232-09
75 mm



Deaver Grip-Handle
MSI-8233-01 25 mm
MSI-8233-02 38 mm
MSI-8233-03 50 mm
MSI-8233-04 75 mm
30 cm/12"



Harrington-Baby
MSI-8234-01
25 cm/10"
24x70 mm
Harrington
MSI-8234-02
MSI-8234-03
32 cm/12½"
40x127 mm
62x127 mm
Harrington
MSI-8234-04
29.5 cm/11½"
64x175 mm



Meyerding

MSI-8235-01
50x16 mm 20cm/8"
MSI-8235-02
75x25 mm 22cm/8¾"
MSI-8235-03
90x50 mm 24cm/9½"

Zenker

MSI-8236-01 25cm/10" 35x08 mm
MSI-8236-02 26cm/10¼" 60x12 mm
MSI-8236-03 27.5cm/10¾" 75x12 mm



MSI-8237-00
Set of 2
Fig. 1
MSI-8237-01
25x75 mm
Fig. 2
MSI-8237-02
25x80 mm

Hibbs
24cm/9½"



MSI-8238-01
45x25 mm
MSI-8238-02
73x28 mm
MSI-8238-03
82x28 mm

Heaney
27cm/10½"

46 mm



Kuemmel
MSI-8239-33
33cm/13"

120x47 mm

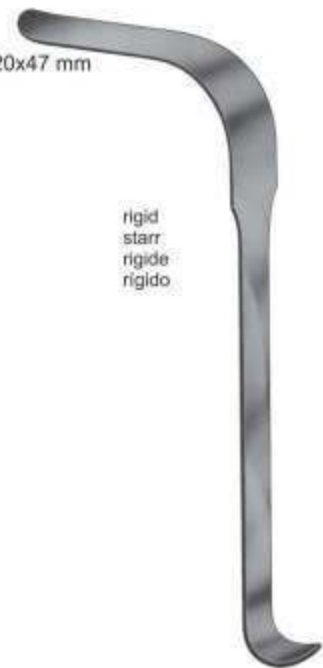

rigid
starr
rigide
rigido

Koerte
MSI-8240-28
28cm/11"

General Instruments

Abdominal and Intestinal Spatulas Spatules abdominale et intestinale
Bauch-und Darm-Spatel Espátulas abdominales e intestinales



Kader
MSI-8241-01 20mm
MSI-8241-02 30mm
MSI-8241-03 40mm
27cm/10½"



MSI-8242-01
25.5cm/10"
45 mm
MSI-8242-02
27.5cm/10¾"
60 mm

Leriché



Malleable
formbar
malléable
maleable

MSI-8243-01	20 mm
MSI-8243-02	25 mm
MSI-8243-03	30 mm
MSI-8243-04	35 mm
MSI-8243-05	40 mm
MSI-8243-06	45 mm
MSI-8243-07	50 mm
MSI-8243-08	64 mm
MSI-8243-09	76 mm
MSI-8243-10	102 mm
	33cm/13"



Malleable
formbar
malléable
maleable



Malleable
formbar
malléable
maleable

MSI-8245-01	200x6 mm
MSI-8245-02	200x8 mm
MSI-8245-03	200x10 mm
MSI-8245-04	200x12 mm
MSI-8245-05	200x17 mm
MSI-8245-06	200x20 mm
MSI-8245-07	200x25 mm
MSI-8245-08	250x25 mm

Tuffier
MSI-8244-20
20 cm/8"
17x25 mm

20cm/8"



Malleable
formbar
malléable
maleable

MSI-8246-01	280x25/30 mm
MSI-8246-02	300x37/45 mm
MSI-8246-03	300x40/50 mm

Haberer



Reverdin
MSI-8247-28
28 cm/11"



Davidson
16cm/6¼"

75x50 mm
75x90 mm

MSI-8248-01
MSI-8248-02



Cooley
MSI-8249-01
21.5cm/8½"



Cooley
MSI-8250-01
21.5cm/8½"



Cooley
MSI-8250-02
23cm/9"



Ross
27cm/10½"

- Fig. 1 MSI-8252-01 13x13 mm
- Fig. 2 MSI-8252-02 14x12 mm
- Fig. 3 MSI-8252-03 18x18 mm
- Fig. 4 MSI-8252-04 20x20 mm
- Fig. 5 MSI-8252-05 22x18 mm
- Fig. 6 MSI-8252-06 26x24 mm

General Instruments

Retractors for Maxillofacial Surgery

Rétracteurs pour la chirurgie maxillo-faciale

Retraktoren für Kiefer-und Gesichtschirurgie

Los retractoros para cirugía maxilofacial

MEDSIGN INSTRUMENTS



60x10 mm



Kirsch
MSI-8253-01
20cm/8"



60x10 mm



Kirsch
MSI-8254-02
20cm/8"



Set
setzen
fixer
establecer
MSI-8255-00

MSI-8255-01
24.5cm/10"

MSI-8255-02
24.5cm/10"



MSI-8256-01
40x12 mm



MSI-8256-02
55x14 mm



Dockhorn
20cm/8"

General Instruments

Retractors for Maxillofacial Surgery
Retraktoren für Kiefer-und Gesichtschirurgie

Rétracteurs pour la chirurgie maxillo-faciale
Los retractores para cirugía maxilofacial

MEDSIGN INSTRUMENTS



Spina-Nasalis
MSI-8257-01
22 cm/8³/₄"

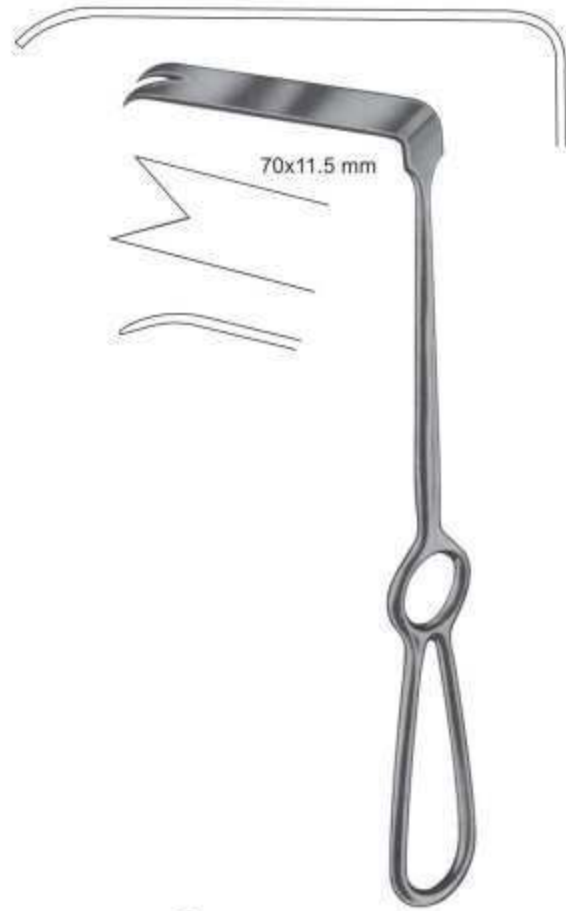

Ramus
MSI-8258-02
22 cm/8³/₄"



Obwegeser
MSI-8259-15
15.5 cm/6"



Obwegeser
MSI-8260-16
16 cm/6¹/₄"

General Instruments

Retractors for Maxillofacial Surgery
Retraktoren für Kiefer-und Gesichtschirurgie

Rétracteurs pour la chirurgie maxillo-faciale
Los retractoros para cirugía maxilofacial



MSI-8261-10 10 mm
MSI-8261-20 20 mm
19cm/7½"



Dingman
MSI-8262-17
17.5cm/7"



Soeresen-Hein
MSI-8263-17
17.5cm/7"



Dingman
MSI-8264-21
21cm/8¼"



MSI-8265-18
18.5cm/7 1/8"

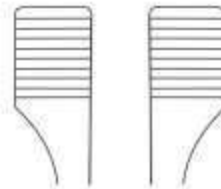

Tessier
MSI-8266-01
15cm/6"



Tessier
MSI-8266-02
15cm/6"



Dingman
MSI-8267-00

General Instruments

Retractors for Maxillofacial Surgery
Retraktoren für Kiefer-und Gesichtschirurgie

Rétracteurs pour la chirurgie maxillo-faciale
Los retractoros para cirugía maxilofacial

MEDSIGN INSTRUMENTS



Obwegeser-Freer
MSI-8268-21
21cm/8¼"



Obwegeser-Freer
MSI-8269-20
20.5cm/8"



Obwegeser
MSI-8270-17
17.5cm/7"



Obwegeser
20cm/8"



MSI-8271-05
5 mm



MSI-8271-08
8 mm



MSI-8271-09
9 mm



Obwegeser
17.5cm/7"



MSI-8272-06
6 mm



MSI-8272-07
7 mm



MSI-8272-09
9 mm



MSI-8272-11
11 mm



Dingman
MSI-8273-18
18cm/7"



Obwegeser
MSI-8274-23
23.5cm/9¼"
10 mm

General Instruments

Osteotome for Maxillofacial Surgery
Osteotome für Kiefer-und Gesichtschirurgie

Ostéotome pour Chirurgie Maxillo-Faciale
Osteotomo de Cirugía Maxilofacial

MEDSIGN INSTRUMENTS



MSI-8275-10
10 mm

MSI-8276-10
10 mm

Tessier
20.5cm/8"



Obwegeser
MSI-8277-01
18.5cm/7 1/4"

Obwegeser
MSI-8278-02
18.5cm/7 1/4"



MSI-8279-07
7 mm
21.5cm/8 1/2"



MSI-8280-10
10 mm
21.5cm/8 1/2"



MSI-8281-02
2.5 mm

MSI-8281-04
4 mm
15cm/6"



Bowdler-Henry's
MSI-8282-16
16.5cm/6 1/2"



Gillies
MSI-8283-21
21cm/8 1/4"



Gillies
MSI-8284-21
21cm/8 1/4"

General Instruments

Awls for Maxillofacial Surgery Alênes pour Chirurgie Maxillo-Faciale
 Ahlen für Kiefer-und Gesichtschirurgie Punzones de Cirugía Oral y Maxilofacial

MEDSIGN INSTRUMENTS



Sanders-Brown
 MSI-8285-30
 30cm/12"



Sanders-Brown
 MSI-8286-29
 29cm/11½"



Obwegeser
 MSI-8287-14
 14cm/5½"



Obwegeser
 MSI-8288-23
 23cm/9"



Obwegeser
 MSI-8289-18
 18cm/7"



Kelsey-Fry
 MSI-8290-16
 15cm/6"



Kelsey-Fry
 MSI-8291-18
 18cm/7"



Mershon
 MSI-8292-14
 14.5cm/5½"

Band Pusher
 Pusher Band

General Instruments

Retractors
Retraktoren

Rétracteurs
Retractoros



Bose



Finsen



Finsen

Sharp
scharf
net
agudo

blunt
stumpf
émousser
embotar

Sharp
scharf
net
agudo

cm	in					
5	2		MSI-8293-05		MSI-8294-05	MSI-8295-05
7	2¾"	MSI-8293-0A	MSI-8293-07		MSI-8294-07	MSI-8295-07 Blunt



Allport
U6-8297-09
9.5cm/3¾"

Aim

Sharp
scharf
net
agudo

blunt
stumpf
émousser
embotar

cm	in		cm	in		
8.5	3½"	MSI-8296-08	7	2¾"	MSI-8298-07	MSI-8299-07
11.5	4½"	MSI-8296-11	10	4	MSI-8298-10	MSI-8299-10



Sharp
scharf
net
agudo

Holzheimer

blunt
stumpf
émousser
embotar

MSI-8300-10 10 cm/4" MSI-8301-10



Sharp
scharf
net
agudo

Jansen

blunt
stumpf
émousser
embotar

MSI-8302-10 10.5 cm/4¼" MSI-8303-10



Sharp
scharf
net
agudo

Jansen-Deep

blunt
stumpf
émousser
embotar

MSI-8304-10 10.5 cm/4¼" MSI-8305-10



Belucci
MSI-8306-11 11.5cm/4½"
MSI-8306-13 13cm/5"



Belucci
MSI-8307-11
MSI-8307-13



Sharp
scharf
net
agudo

Plester

blunt
stumpf
émousser
embotar

MSI-8308-13 13 cm/5" MSI-8309-13

General Instruments

Retractors
Retraktoren

Rétracteurs
Retradores



Sharp
scharf
net
agudo

Weitlaner

blunt
stumpf
émousser
embotar

MSI-8311-10



Sharp
scharf
net
agudo

Weitlaner

blunt
stumpf
émousser
embotar

MSI-8312-13

MSI-8313-13

MSI-8312-16

MSI-8313-16



Weitlaner-Wullstein

Sharp
scharf
net
agudo

blunt
stumpf
émousser
embotar

MSI-8314-13

MSI-8315-13

MSI-8314-16

MSI-8315-16

10.5 cm/4¼"

MSI-8310-10

13 cm/5"

16.5 cm/6½"



Mollison
MSI-8316-15
15 cm/6"

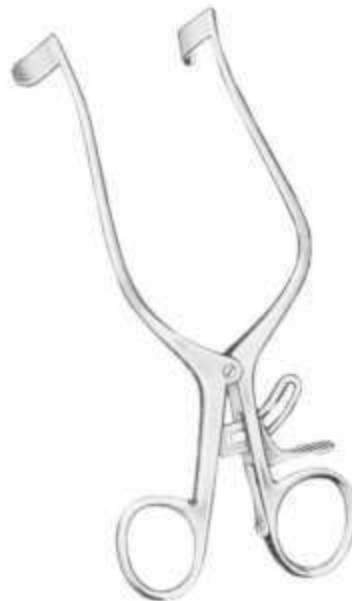

Tuebinger-Modell
MSI-8317-16
16 cm/6¼"



Henner(Lempert)
MSI-8318-12
12 cm/4½"

Complete with 2 pairs of blades and centre blade.
Komplett mit 2 Paar Klängen und mittlere Klängen
Livré avec 2 paires de les lames et les lames centre
Completo con 2 pares de cuchillas y la cuchilla centro

General Instruments

Retractors
Retraktoren

Rétracteurs
Retradores

MEDSIGN INSTRUMENTS

Complete with 3 Central blades
Komplett mit 3 Central Klängen
Livré avec 3 lames centrales
Completo con 3 cuchillas centrales



Sharp
scharf
net
agudo

Henley

blunt
stumpf
émousser
embotar

MSI-8319-16

16.5 cm/6½"

MSI-8320-16

Central blades, only
Zentral Klängen, nur
Lames centrales, ne
Hojas centrales, sólo



MSI-8321-19
16x19 mm

MSI-8321-25
16x25 mm

MSI-8321-32
16x32 mm



Weitlaner-Baby

13 cm/5"
16 cm/6½"

MSI-8322-13



Sharp
scharf
net
agudo

Milligan

blunt
stumpf
émousser
embotar

MSI-8323-13

MSI-8324-13



Sharp
scharf
net
agudo

Cone (Adson-Baby)

blunt
stumpf
émousser
embotar

MSI-8325-13

MSI-8325-16

MSI-8326-13

MSI-8326-16

General Instruments

Retractors
Retraktoren

Rétracteurs
Retractoros



Weitlaner

20 cm/8"
25 cm/10"



3x4 Teeth

Sharp
scharf
net
agudo

MSI-8327-20
MSI-8327-25

blunt
stumpf
émousser
embotar

MSI-8328-20
MSI-8328-25



5x6 Teeth

Sharp
scharf
net
agudo

MSI-8329-25

blunt
stumpf
émousser
embotar

MSI-8330-25



Adson

Sharp
scharf
net
agudo

20 cm/8"
26 cm/10 1/4" MSI-8331-26

blunt
stumpf
émousser
embotar

MSI-8332-20
MSI-8332-26



Anderson-Adson

Sharp
scharf
net
agudo

MSI-8333-20

blunt
stumpf
émousser
embotar

MSI-8334-20



Cone

Sharp
scharf
net
agudo

MSI-8335-20
MSI-8335-26

blunt
stumpf
émousser
embotar

MSI-8336-20
MSI-8336-26



Travers
MSI-8337-21
21 cm/8¼"

Jaws Depth

25 mm
44 mm

MSI-8338-01
MSI-8338-02



Beckmann-Adson

31 cm/12¼"

Sharp
scharf
net
agudo

blunt
stumpf
émousser
embotar

MSI-8339-01
MSI-8339-02



Adson

27 cm/10½"

Sharp
scharf
net
agudo

blunt
stumpf
émousser
embotar

MSI-8340-27

MSI-8341-27

General Instruments

Retractors
Retraktoren

Rétracteurs
Retradores



5x6 Teeth

Sharp
scharf
net
agudo

Adson

blunt
stumpf
émousser
embotar

MSI-8342-27 27cm/10½" MSI-8343-27



Beckmann

MSI-8344-01 10mm 14cm/5½"
MSI-8344-02 12mm 17cm/6¾"
MSI-8344-03 15mm 21cm/8¼"
MSI-8344-04 20mm
MSI-8344-05 30 mm
MSI-8344-06 50mm
30 cm/12"



Sharp
scharf
net
agudo

BeckMann

blunt
stumpf
émousser
embotar

MSI-8345-31 31cm/12¼" MSI-8345-31

General Instruments

Abdominal Retractors
Bauchdeckenhalter

Rétracteurs abdominale
Los retractoros abdominales

Hemilaminectomy Retractor
Hemilaminectomie Retraktor
enrouleur hémi laminectomie
hemilaminectomia retractor



MSI-8346-27
27cm/10½"



Beckmann-Eaton
MSI-8347-33
33 cm/13"

Retractors Only
Wundhaken Nur
Solo Retractores...

Lateral Blades
seitlichen Flügel
lames latérales
cuchillas laterales

MSI-8348-01

MSI-8348-02



Collin
MSI-8348-00
22cm/8¾"

General Instruments

Abdominal Retractors
Bauchdeckenhalter

Rétracteurs abdominale
Los retractoros abdominales



Collin
22 cm/8¾"

Retractors Complete
Wundhaken Vollständige
Ecarteurs complètes
Retractoros completos

Retractors Only
Wundhaken Nur
Sólo Retractoros...
Seulement Rétracteurs

Lateral Blades
seitlichen Flügel
lames latérales
cuchillas laterales

Central Blades
zentralen Klängen
lames centrales
paletas centrales

Fig. 1	Fig. 2	Fig. 3
MSI-8349-00	MSI-8350-00	MSI-8351-00
MSI-8349-01	MSI-8350-01	MSI-8351-01
MSI-8349-02 38x60 mm	MSI-8350-02 38x80 mm	MSI-8351-02 38x100 mm
MSI-8349-03 55x55 mm		MSI-8351-03 55x75 mm



Baby-Collin
MSI-8352-00
18 cm/7"

with 2 pairs of blades
mit 2 Messerpaaren
avec 2 paires de lames
con 2 pares de cuchillas



MSI-8352-01

General Instruments

Abdominal Retractors Rétracteurs abdominale
Bauchdeckenhalter Los retractorés abdominales

MEDSIGN INSTRUMENTS



Collin

26 cm/10 1/2"

Retractors Complete
Wundhaken Vollständige
Ecarteurs complètes
Retractorés completos

MSI-8353-00

26cm/10 1/2"

Lateral Blades
seitlichen Flügel
lames latérales
cuchillas laterales

MSI-8353-01

60X80mm

Central Blades
zentralen Klängen
lames centrales
palelas centrales

MSI-8353-02

75X60mm

Retractors Only
Wundhaken Nur
Solo Retractorés...
Seulement Rétracteurs.

MSI-8353-03



Mayo-Adams

MSI-8354-17

17cm/6 3/4"



Mayo-Adams

MSI-8355-17

17cm/6 3/4"

General Instruments

Abdominal and Vulval Retractors Rétracteurs abdominaux et de la vulve
 Bauch-und Vulva Retraktoren Los retractoros abdominales y la vulva

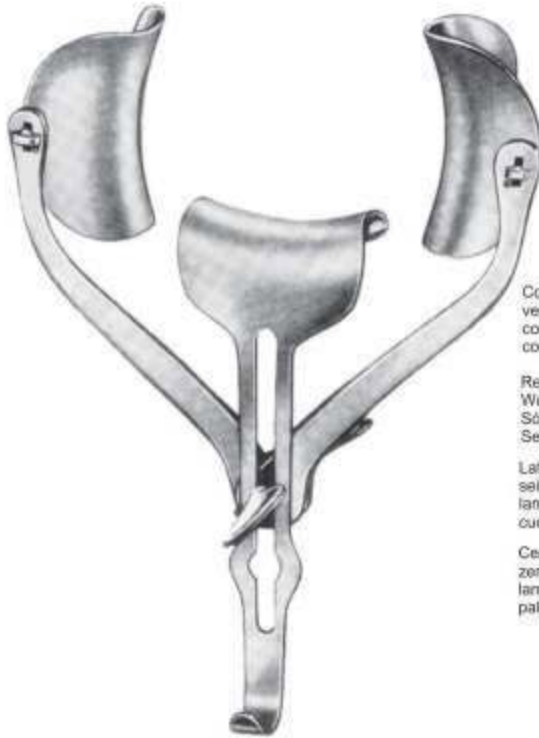

Ricard
 MSI-8356-28 28cm/11"
 MSI-8356-30 30cm/12"

Complete
 vervollständigen
 completér
 completar

Retractors Only
 Wundhaken Nur
 Sólo Retractores...
 Seulement Rétracteurs.

Lateral Blades
 seitlichen Flügel
 lames latérales
 cuchillas laterales

Central Blades
 zentralen Klingen
 lames centrales
 paletas centrales

Fig. 1
 MSI-8356-00

Fig. 2
 MSI-8357-00

MSI-8356-01

MSI-8357-01

MSI-8356-02
 60x80 mm

MSI-8357-02
 75x85 mm

MSI-8356-03
 55x70 mm

MSI-8357-03
 80x90 mm

Vulval Retractor
 Vulva Retractor
 Écarteur vulvaire
 Retractor vulvar



Richter
 MSI-8358-16
 16.5 cm/6 1/2"



Gelpi
 MSI-8360-09 9 cm/3 1/2"
 MSI-8360-11 11 cm/4 1/2"
 MSI-8360-13 13 cm/5"
 MSI-8360-18 18 cm/7"



Gelpi
 MSI-8361-18
 18 cm/7"



Meyerding
 Fig. 1 MSI-8362-01
 Fig. 2 MSI-8362-02
 Fig. 3 MSI-8362-03
 Fig. 4 MSI-8362-04
 18 cm/7"

blades
 Klingen
 Lames
 Hojas

Fig. 1 1 3/4"x1"
 Fig. 2 2 1/8"x1"
 Fig. 3 2 3/8"x1 3/4"
 Fig. 4 2 3/8"x1"

General Instruments

Abdominal Retractors Rétracteurs abdominale
Bauchdeckenhalter Los retractoros abdominales

MEDSIGN INSTRUMENTS



Markham-Meyerdig

MSI-8363-18 18cm/7" MSI-8364-18



Rigby

MSI-8365-19
19cm/7½"



De Bakey

MSI-8366-12 12cm/4¾"
MSI-8366-17 17cm/6¾"



10cm/4"

40x30mm



Gosset
MSI-8367-00

140mm

63x35mm



Gosset
MSI-8368-00

General Instruments

Abdominal Retractors
Bauchdeckenhalter

Rétracteurs abdominale
Los retractoros abdominales



Gosset
MSI-8369-16

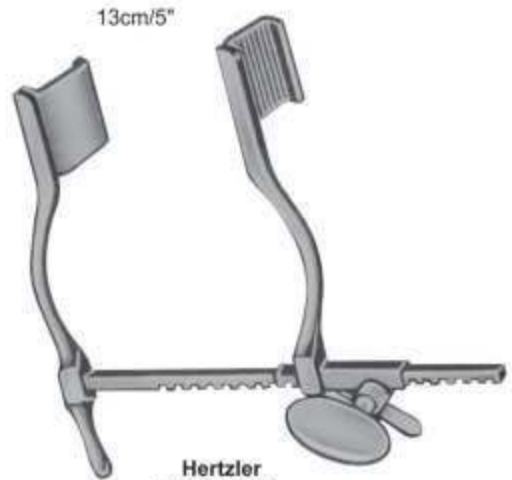

Hertzler
MSI-8370-00

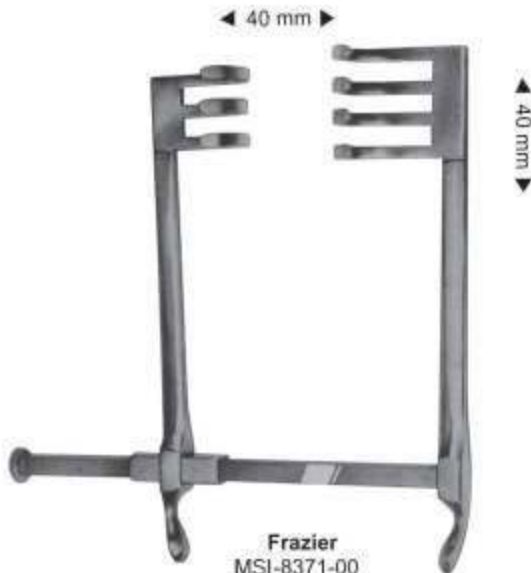

Frazier
MSI-8371-00

the blades are available by pairs
die Schaufeln sind durch Paare
les lames sont disponibles par paires
Las cuchillas están disponibles por pares

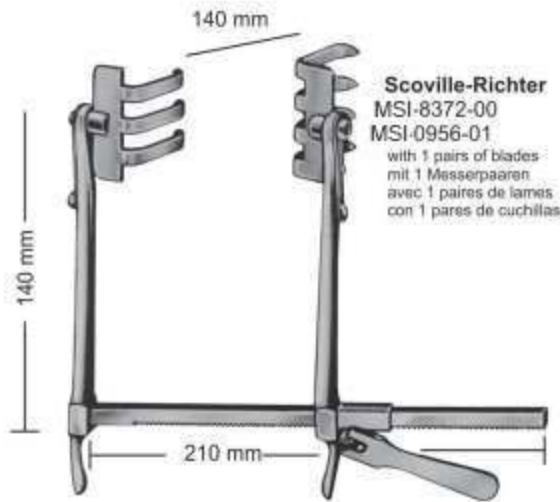

MSI-8373-01
60x50 mm

MSI-8373-02
48x50 mm



MSI-8373-03
28x40 mm



MSI-8373-04
38x62 mm



Scoville
MSI-8375-02
51 mm



Scoville
MSI-8375-03 63x25 mm
MSI-8375-04 63x51 mm
MSI-8375-05 67x32 mm
MSI-8375-06 89x25 mm



Taylor
MSI-8375-07
48x38 mm



Taylor
MSI-8375-08 63x51 mm
MSI-8375-09 79x57 mm

General Instruments

Abdominal Retractors
Bauchdeckenhalter

Rétracteurs abdominale
Los retractoros abdominales

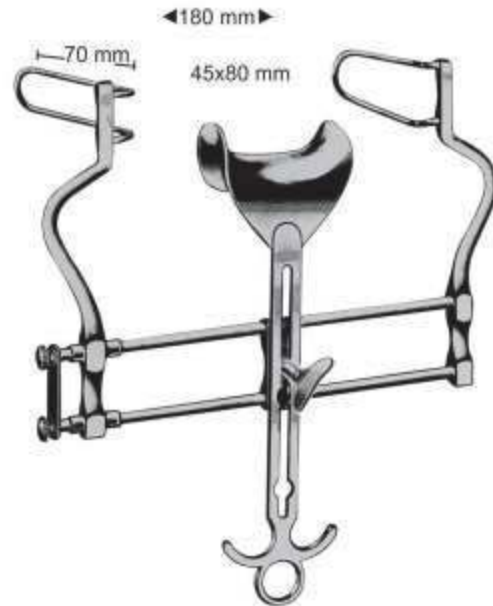

Retractors Complete
Wundhaken Vollständige
Ecarteurs complètes
Retradores completos

Baby-Balfour
MSI-8376-00

Balfour
MSI-8377-18

Retractors Only
Wundhaken Nur
Sólo Retradores...
Seulement Rétracteurs

MSI-8376-01

MSI-8377-01

Central Blades
zentralen Klängen
lames centrales
paletas centrales

MSI-8376-02
24x20mm

MSI-8377-02
45x80mm

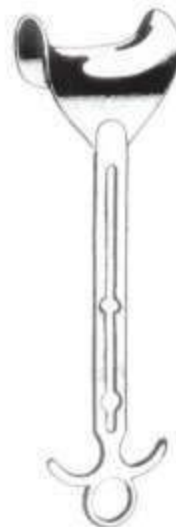

Balfour
MSI-8378-01 80x90mm

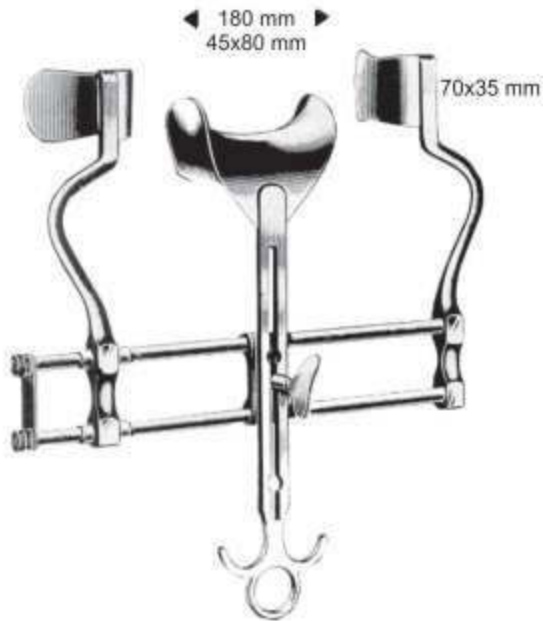

Balfour

Retractors Complete
Wundhaken Vollständige
Ecarteurs complètes
Retractoros completos

MSI-8379-18

Retractors Only
Wundhaken Nur
Solo Retractoros...
Seulement Rétracteurs

MSI-8379-01

Central Blades
zentralen Klängen
lames centrales
paletas centrales

MSI-8379-02
45x80mm

Solid blade

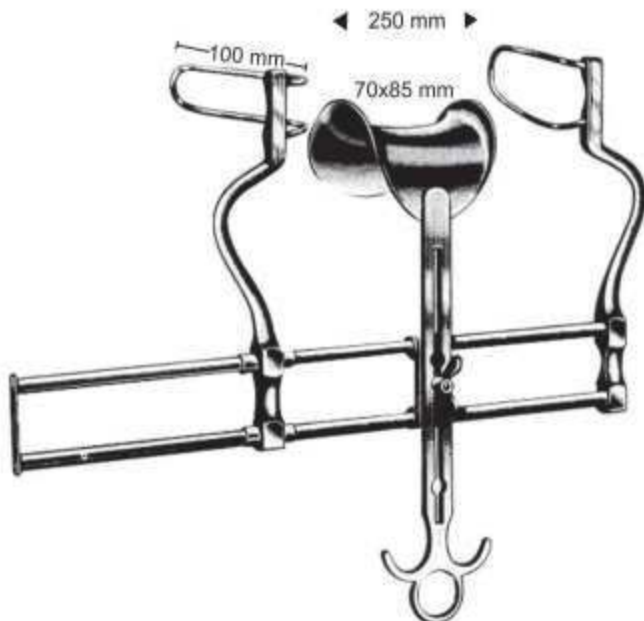

Balfour
MSI-8380-25

Retractors Complete
Wundhaken Vollständige
Ecarteurs complètes
Retractoros completos

MSI-8380-25

Retractors Only
Wundhaken Nur
Solo Retractoros...
Seulement Rétracteurs

MSI-8380-01

Central Blades
zentralen Klängen
lames centrales
paletas centrales

MSI-8380-02
70x85mm

General Instruments

Abdominal Retractors
Bauchdeckenhalter

Rétracteurs abdominale
Los retractoros abdominales



Retractors Complete
Wundhaken Vollständige
Ecarteurs complètes
Retractoros completos

MSI-8381-20

Retractors Only
Wundhaken Nur
Sólo Retractoros...
Seulement Rétracteurs

MSI-8381-01

Central Blades
zentralen Klingen
lames centrales
paletas centrales

MSI-8381-02

100x70mm



Balfour us-Type
MSI-8382-00
Complete



MSI-8383-01

Lateral blades, 6cm deep, per pair
seitliche Flügel, 6cm tief, pro Paar
lames latérales, 6cm de profondeur, par paire
cuchillas laterales, 6cm par profunda, por

MSI-8383-02

Lateral blades, 8cm deep, per pair
seitliche Flügel, 8cm tief, pro Paar
lames latérales, 8cm de profondeur, par paire
cuchillas laterales, 8cm par profunda, por

Central Blades only
zentralen Klingen
lames centrales Sólo
Seulement paletas centrales

MSI-8383-03

40x68mm

MSI-8383-04

68x85mm

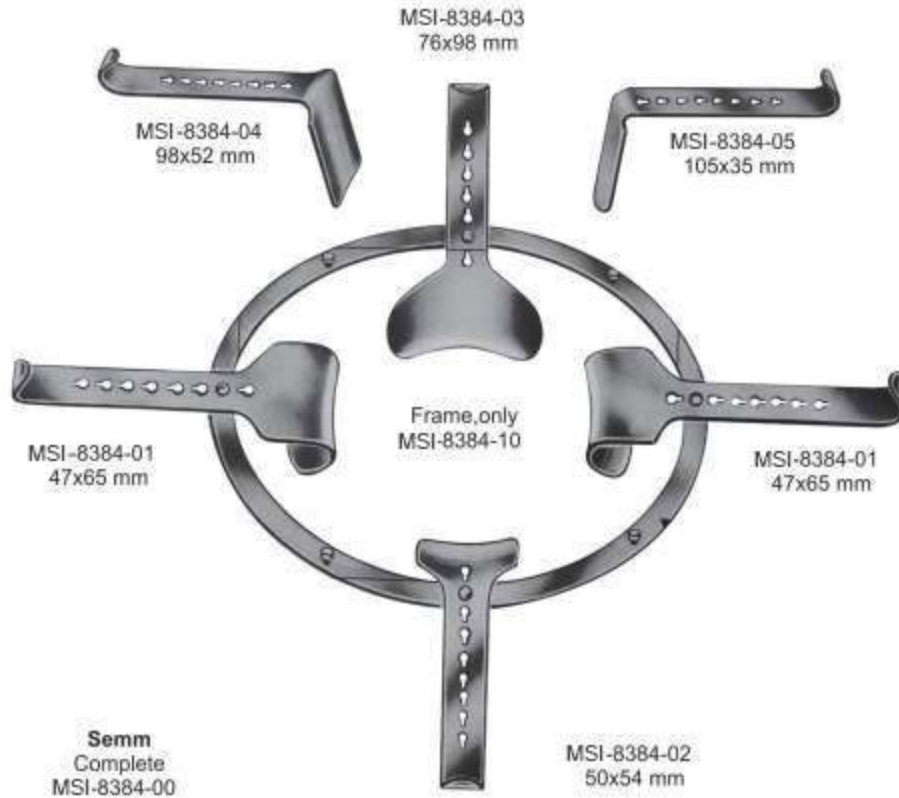

Complete
vervolständigen
completer
completer

40x55 mm MSI-8385-01
50x65 mm MSI-8385-02
65x80 mm MSI-8385-03
80x80 mm MSI-8385-04
90x65 mm MSI-8385-05
90x90 mm MSI-8385-06



Kirschner

Complete
MSI-8386-00
1x MSI-8386-10
2x MSI-8386-01
2x MSI-8386-02

General Instruments

Abdominal Retractors
Bauchdeckenhalter

Rétracteurs abdominale
Los retractoros abdominales

Frame
MSI-8387-10 178x140 mm
MSI-8388-20 255x178 mm



Complete
vervolständigen
completar

MSI-8387-00
MSI-8388-00

Denis-Brown

Consisting of
bestehend aus
composée d'
Compuesto por

1xMSI-8389-10
1xMSI-8390-20

Fig.1 MSI-6359-01 38x38 mm

Fig.2 MSI-6360-02 38x25 mm



2x MSI-83859-01
2x MSI-8390-01

2x MSI-8389-02
2x MSI-8390-02



110x70 mm

Complete
vervolständigen
completar

O'Sullivan-O'Connor
MSI-8391-00



MSI-8391-01
80x45 mm



MSI-8391-02
80x45 mm



MSI-8391-03
110x70 mm



Doyen

MSI-8392-01 48x90mm
MSI-8392-02 48x105mm
MSI-8392-03 48x120mm
MSI-8392-04 48x135 mm



Rochard

MSI-8393-01 40x80mm
MSI-8393-02 50x100mm
MSI-8393-03 55x120mm



Doyen-Rochard

MSI-8394-01 45x80mm
MSI-8394-02 50x100mm
MSI-8394-03 65x120mm



General Instruments

Abdominal Retractors
Bauchdeckenhalter

Rétracteurs abdominale
Los retractoros abdominales



MSI-8396-19
19 cm/7½"

MSI-8397-10
Foldable frame
Faltrahmen
cadre pliant
marco plegable

MSI-8397-01 38x60 mm
MSI-8397-02 45x80 mm



Franz

Complete with 4 valves
Komplett mit 4 Ventilen
Fourni avec 4 soupapes
Completa con 4 válvulas
MSI-8397-40
Complete with 8 valves
Komplett mit 8 Ventilen
Fourni avec 8 soupapes
Completa con 8 válvulas
MSI-8397-80

MSI-8397-03 50x65 mm
MSI-8397-04 60x85 mm

With
con
MSI-8397-10 1x
MSI-8397-01 2x
MSI-8397-03 2x
MSI-8397-10 1x
MSI-8397-01 2x
With
con
MSI-8397-02 2x
MSI-8397-03 2x
MSI-8397-04 2x

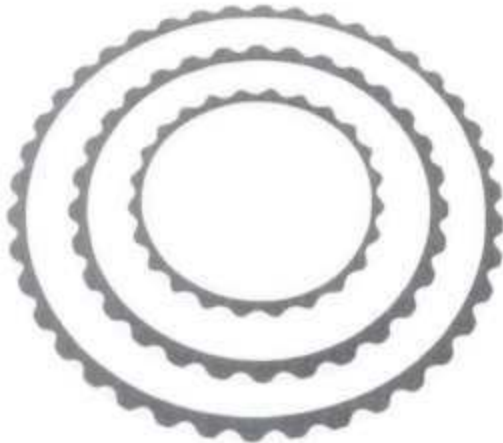

MSI-1368-00 Complete Set

Turner Warwick
1xMSI-8398-18 18cm/7" Round
1xMSI-8398-23 23cm/9" Round
1xMSI-8398-30 30cm/12" Round
1xMSI-8398-45 45cm/18" Oval
33cm/13"

Copper Blade



2xMSI-8398-01
19 x 76 mm

2xMSI-1368-02
57 x 89 mm

2xMSI-8398-04
57 x 114 mm



2xMSI-8398-05
76 x 60 mm

2xMSI-8398-06
51 x 38 mm



2xMSI-8398-07
89 x 60 mm

2xMSI-8398-08
114 x 60 mm