

Stomach, Intestine and Rectum Instruments

Tissue Seizing Forceps and Intestinal
Atrauma Tissue Forceps

Saisir les tissus Intestinaux et Pince Forceps tissus atraumatique
Aprovechando los tejidos Pinzas Pinzas intestinales y
tisulares Atrauma

Tissue ergriff Pinzetten und Darm Atrauma Pinzette



Baby-Allis

MSI-9632-12 12 cm/4¾"
MSI-9632-14 14 cm/5½"



Allis

cm	in	4 : 5	5 : 6
15	6"	MSI-9633-15	MSI-9634-15
19	7½"	MSI-9634-19	MSI-9634-19
25	10"	MSI-9634-25	MSI-9634-25



Allis-Atrauma

MSI-9635-16 16 cm/6¼"
MSI-9635-20 20 cm/8"
MSI-9635-25 25 cm/10"
MSI-9635-30 30 cm/12"



Allis-Adair
MSI-9636-15
15 cm/6"



Baby-Allis
MSI-9637-15
15 cm/6"



Lockwood-Allis
MSI-9638-16 16 cm/6¼"
MSI-9637-20 20 cm/8"



Thomas-Allis
MSI-9639-20
20 cm/8"

Stomach, Intestine and Rectum Instruments

Intestinal Tissue Forceps, Atrauma,
and Tungsten Carbide inserts

Intestinale Pinzette, Atrauma, und Hartmetalleinlagen

Pince tissu intestinal, atraumatique, et de carbure de tungstène

Pinzas intestinales y tisulares Atrauma, y los recubros de carburo de tungsteno

MEDSIGN INSTRUMENTS

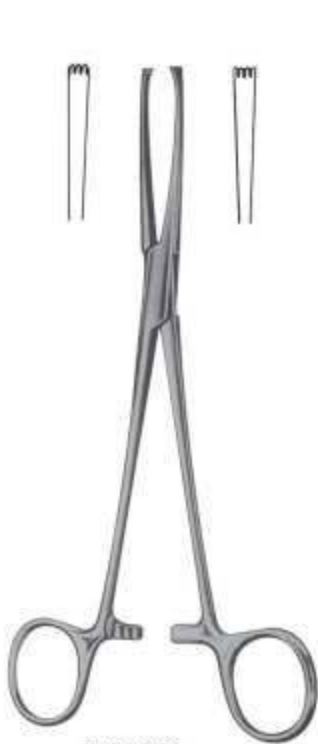

Judd-Allis

MSI-9640-15 15 cm/6"
MSI-9640-19 19 cm/7 1/2"



Littlewood
MSI-9641-18
18.5 cm/7 1/4"



Williams
MSI-9642-16
16 cm/6 1/4"



Lockwood
MSI-9643-20
20 cm/8"



Babcock-Atrauma

cm/in
16 cm/6 1/4" MSI-9644-16
18 cm/7" MSI-9644-20
20 cm/8" MSI-9644-20
24 cm/9 1/2" MSI-9644-24



Babcock(Standard)

MSI-9645-16
MSI-9645-18
MSI-9645-20
MSI-9645-24



Baby-Babcock
U18-9646-16



Babcock
MSI-9647-16

MSI-9647-20

Stomach, Intestine and Rectum Instruments

Intestinal Tissue and Organ Grasping Forceps Tissue intestinal et Pince Grasping organes
 Darmgewebe und Orgel Grasping Zange Pinzas de tejido intestinal y órganos Grasping



MSI-9648-18
18 cm/7"



MSI-9648-20
20 cm/8"



MSI-9648-23
23 cm/9"

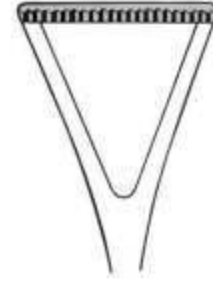

	Duval	
	cm	in
MSI-9649-18	18	7"
MSI-9649-20	20	8"
MSI-9649-23	23	9"
	MSI-9650-20	
	MSI-9650-23	



Duval
MSI-9651-20
20 cm/8"



Gregoire
MSI-9652-16 16 cm/6 1/4"
MSI-9652-18 18 cm/7"
MSI-9652-20 20 cm/8"
MSI-9652-22 22 cm/8 3/4"



Coeur



MSI-9653-25
24 cm/10"



MSI-9653-26
26 cm/10 1/4"



Baby-Doyen

MSI-9654-18
18 cm/7"
Straight
gerade
droit
recto

MSI-9655-18
18 cm/7"
Curved
Gebogene
courbe
Curvo

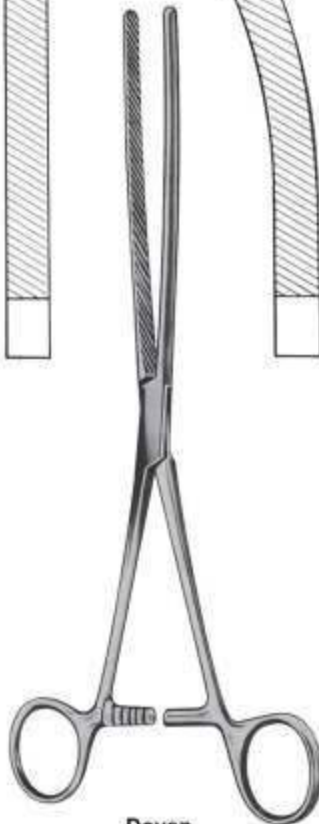

Doyen

MSI-9656-21 21 cm/8¼"
MSI-9656-23 23 cm/9"
Straight
gerade
droit
recto

MSI-9657-21 21 cm/8¼"
MSI-9657-23 23 cm/9"
Curved
Gebogene
courbe
Curvo

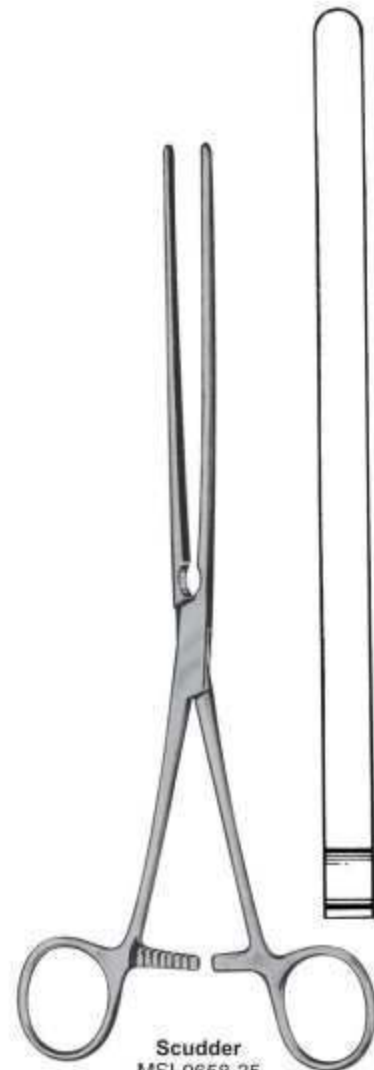

Scudder
MSI-9658-25
25 cm/10"

Stomach, Intestine and Rectum Instruments

Atrauma Intestinal Clamps Forceps Atraumatique intestinaux Forceps Pinces
 Atrauma Darmklammern Zange Atrauma Abrazaderas Pinzas intestinales



Doyen-Atrauma

Straight
gerade
droit
recto



MSI-9658-13
13 cm/5"



MSI-9658-16
16 cm/6 1/4"



MSI-9658-18
18 cm/7"



MSI-9658-21
21 cm/8 1/4"



MSI-9658-23
23 cm/9"

Curved
Gebogene
courbe
Curvo

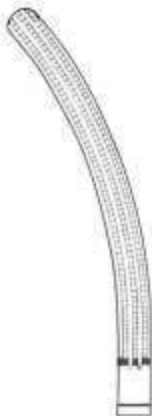

MSI-9659-13
13 cm/5"

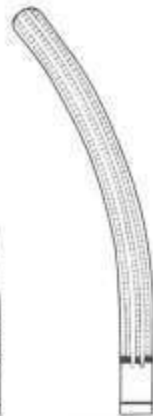

MSI-9659-16
16 cm/6 1/4"



MSI-9659-18
18 cm/7"



MSI-9659-21
21 cm/8 1/4"



MSI-9659-23
23 cm/9"



Mayo-Robson
Mayo-Robson Atrauma

Straight	Curved
gerade	Gebogene
droit	courbe
recto	Curvo



MSI-9660-21
21 cm/8 1/4"



MSI-9661-21
21 cm/8 1/4"



MSI-9662-23
23 cm/9"



MSI-9663-23
23 cm/9"



MSI-9664-25
25 cm/10"

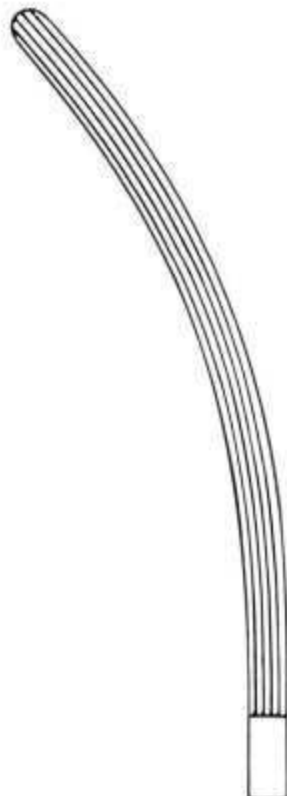

MSI-9665-25
25 cm/10"



MSI-9666-25
25 cm/10"



MSI-9667-25
25 cm/10"

Stomach, Intestine and Rectum Instruments

Intestinal Clamps Forceps
Darmklammern Zange

Intestinaux Forceps Pincers
Pinzas Pinzas intestinales



Resano
MSI-9668-30
30 cm/12"



Hayes



MSI-9669-26
26 cm/10 1/4"

MSI-9669-28
28 cm/11"

Stomach, Intestine and Rectum Instruments

Intestinal Clamps Forceps
Darmklammern Zange

Intestinaux Forceps Pincers
Pinzas Pinzas intestinales



Fehland
MSI-9670-24
24 cm/9½"



Brunner
24 cm/9½"

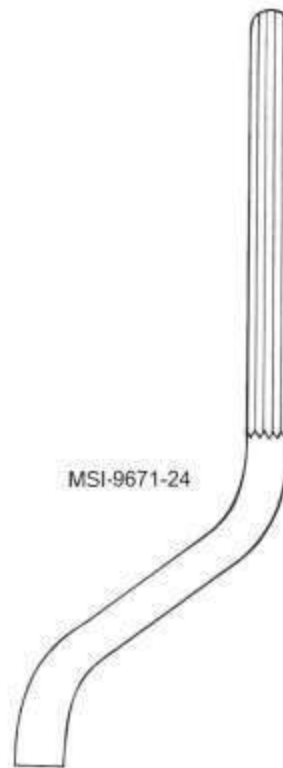

MSI-9671-24



MSI-9672-24



Baby-Kocher

MSI-9673-13
13 cm/5"
Straight
gerade
droit
recto

MSI-9674-13
13 cm/5"
Curved
Gebogene
courbe
Curvo

Straight
gerade
droit
recto

Curved
Gebogene
courbe
Curvo



Kocher



MSI-9675-01
22 cm/8¾"



MSI-9675-02
25 cm/10"



MSI-9675-03
28 cm/11"



MSI-9675-04
22 cm/8¾"



MSI-9675-05
25 cm/10"

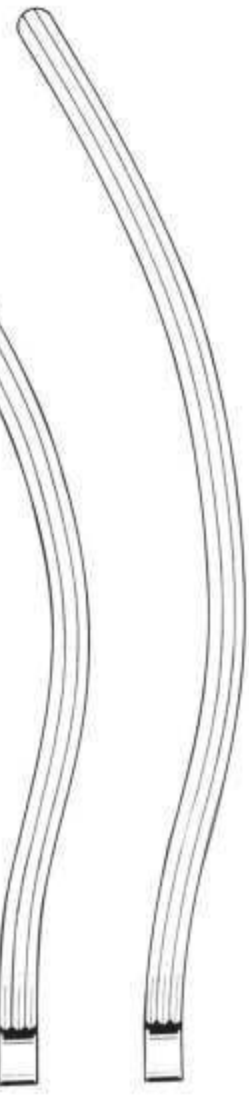

MSI-9675-06
28 cm/11"

Stomach, Intestine and Rectum Instruments

Atrauma Intestinal Clamps Forceps Atraumatique intestinaux Forceps Pinces
 Atrauma Darmklammern Zange Atrauma Abrazaderas Pinzas intestinales

MEDSIGN INSTRUMENTS



Kocher-Atrauma

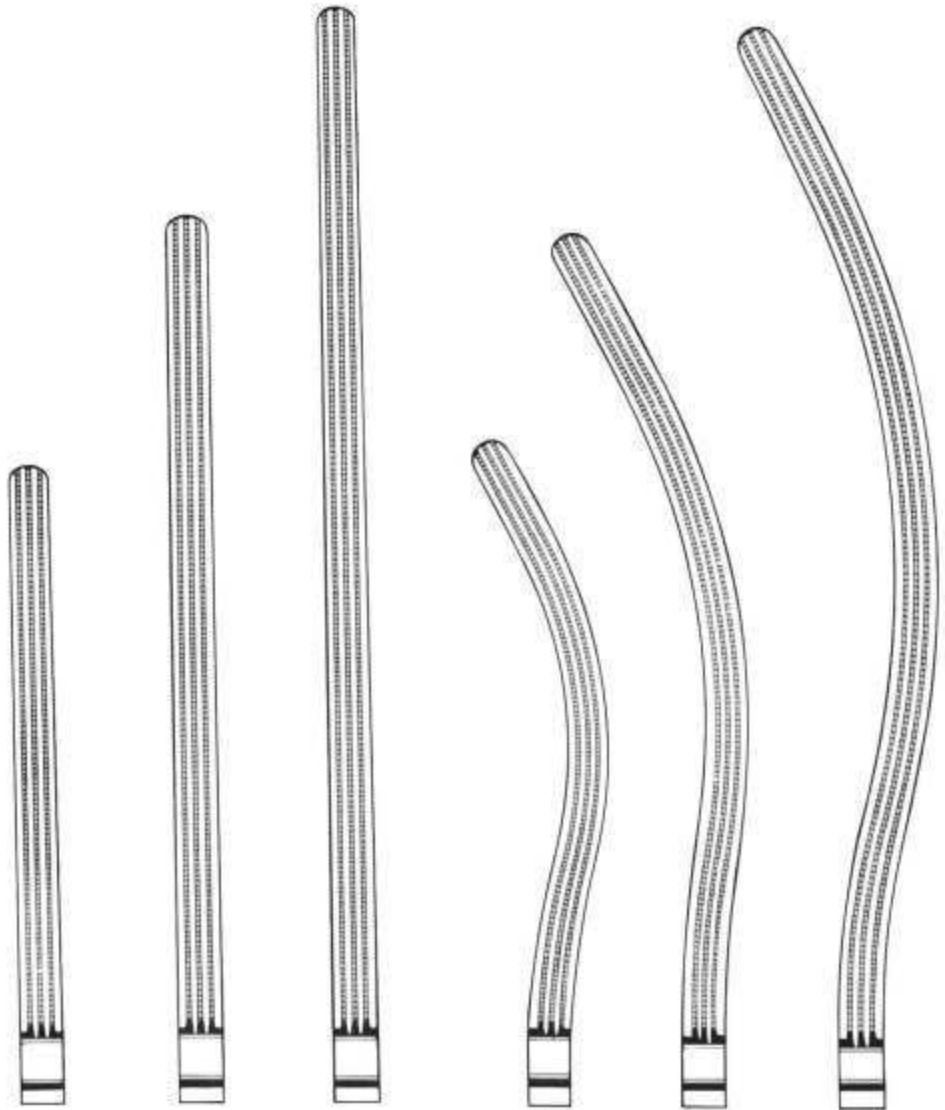

MSI-9676-01
22 cm/8¾"

MSI-9676-02
25 cm/10"

MSI-9676-03
28 cm/11"

MSI-9676-04
22 cm/8¾"

MSI-9676-05
25 cm/10"

MSI-9676-06
28 cm/11"

Stomach, Intestine and Rectum Instruments

Intestinal Clamps Forceps
Darmklammern Zange

Intestinaux Forceps Pincers
Pinzas Pinzas intestinales



MSI-9677-25
Straight
gerade
droit
recto

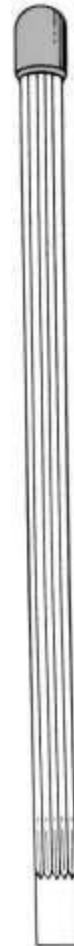

Nussbaum
25 cm/10"

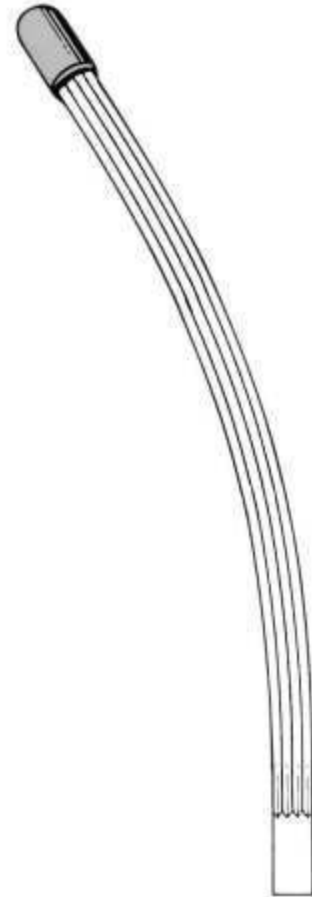

MSI-9678-25
Curved
Gebogene
courbe
Curvo

Pylorus spreader



Benson
MSI-9679-15
15.5 cm/6"



Allen
MSI-9680-15 15.5 cm/6"
MSI-9680-20 20.0 cm/8"

Blindgut forceps



Kleinschmidt
MSI-9681-12
12 cm/4 3/4"

Stomach, Intestine and Rectum Instruments

Intestinal and Stomach Clamps Forceps Intestinaux et de l'Estomac Forceps Pincas
 Magen-und Klemmen Pinzetten Intestinales y el estómago Pinzas Pinzas

Twin Clamps Forceps
 Doppelschlauchklemmen Forceps
 Pincas Pincas jumeaux
 Pinzas Pinzas Gemelas

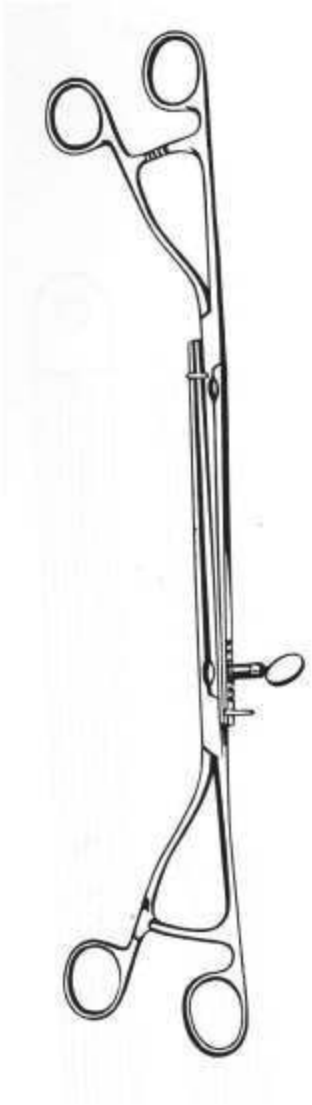

Lane
 30 cm/12"



MSI-9686-30
 Straight
 gerade
 droit
 recto

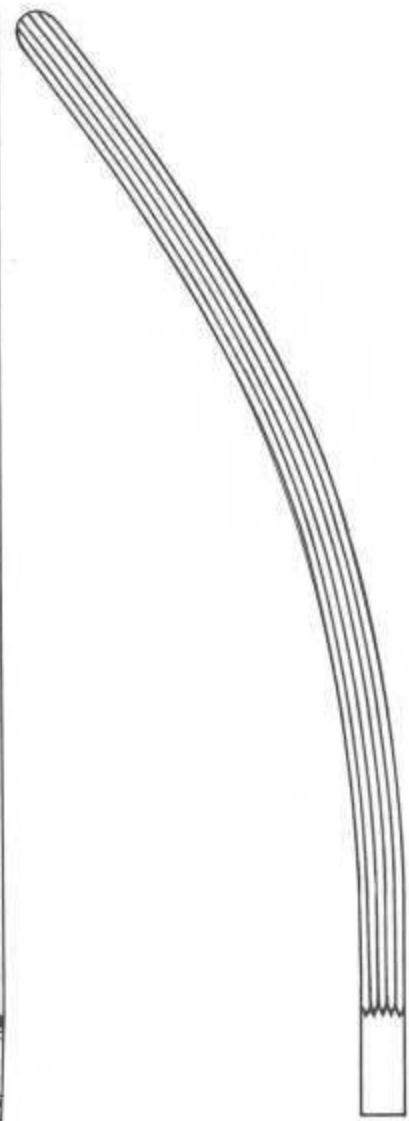

MSI-9687-30
 Curved
 Gebogene
 courbe
 Curvo

Stomach, Intestine and Rectum Instruments

Intestinal Stomach Clamps
Darm-Magen-Schellen

Pinces estomac intestinaux
Abrazaderas intestinales estómago

MEDSIGN INSTRUMENTS



Payr
(Payr-Baby)

For children
für Kinder
pour les enfants
Para los niños

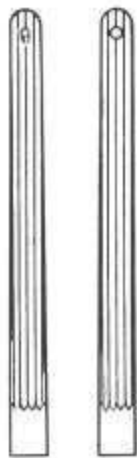

MSI-9688-15
15 cm/6"

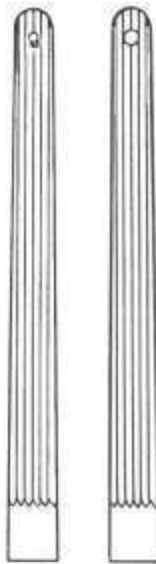

MSI-9689-21
21 cm/8¼"

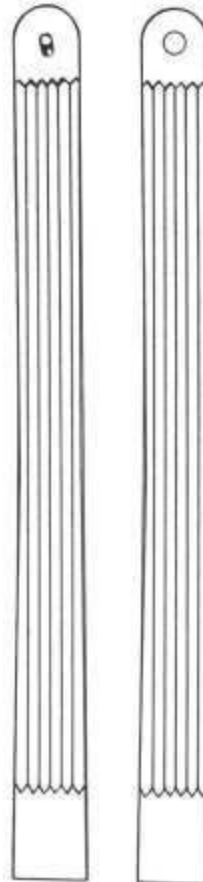

MSI-9690-29
29 cm/11½"

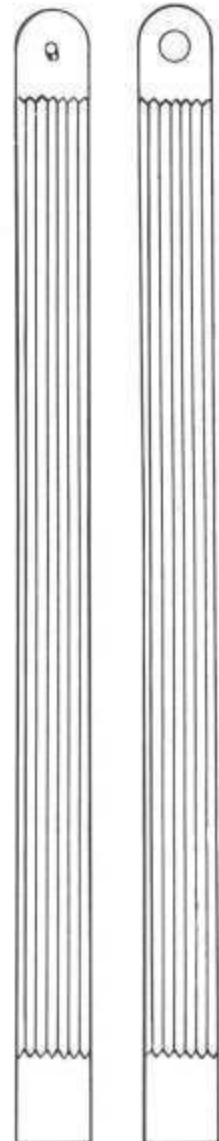

MSI-9691-35
35 cm/13¾"



Scudder
Scudder-Atraume
33 cm/13"



MSI-9692-33
Straight
gerade
droit
recto

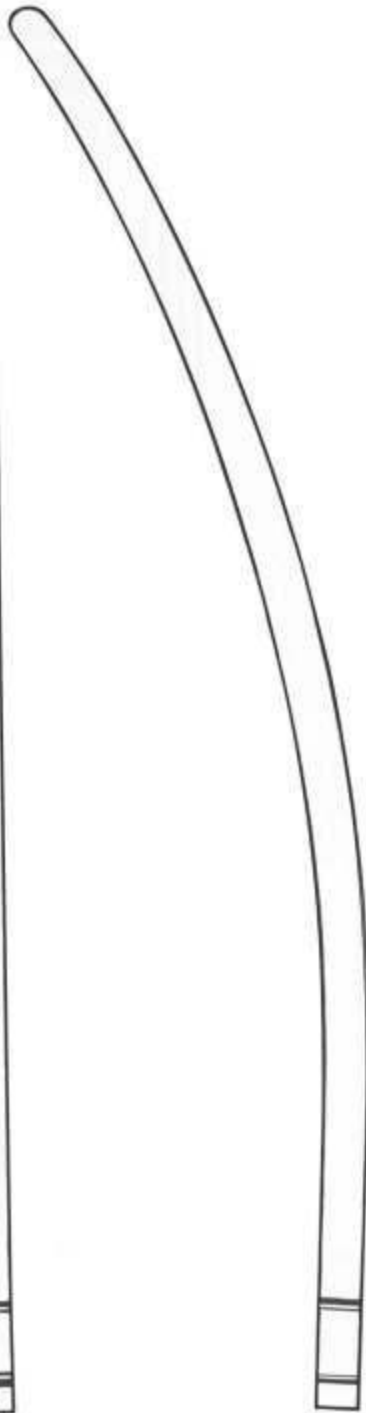

MSI-9693-33
Curved
Gebogene
courbe
Curvo



MSI-9694-33
Straight
gerade
droit
recto

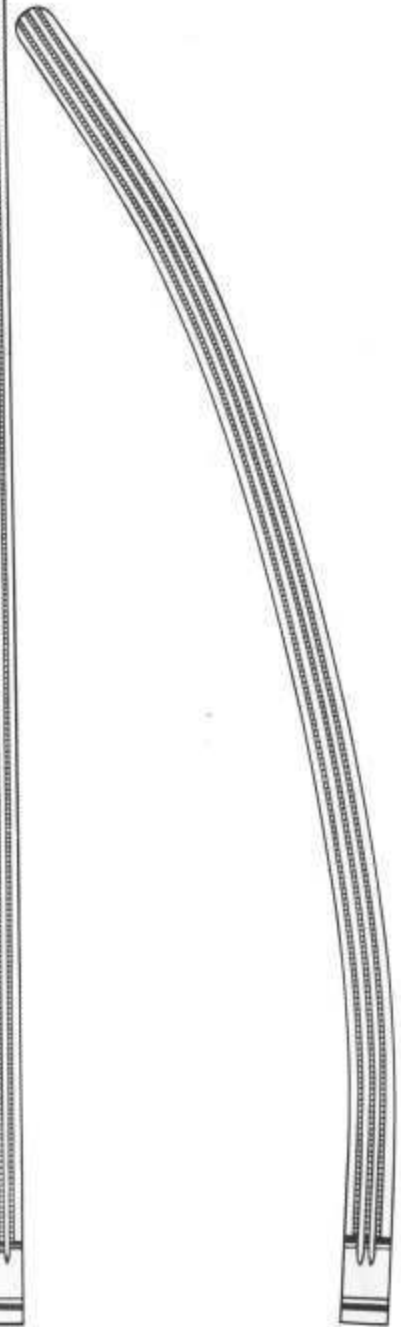

MSI-9695-33
Curved
Gebogene
courbe
Curvo

Stomach, Intestine and Rectum Instruments

Stomach Clamp Forceps
Magen Klammerzange

Estomac Forceps Clamp
Estómago pinza fórceps



Haberer
MSI-9696A-36
36 cm/14"

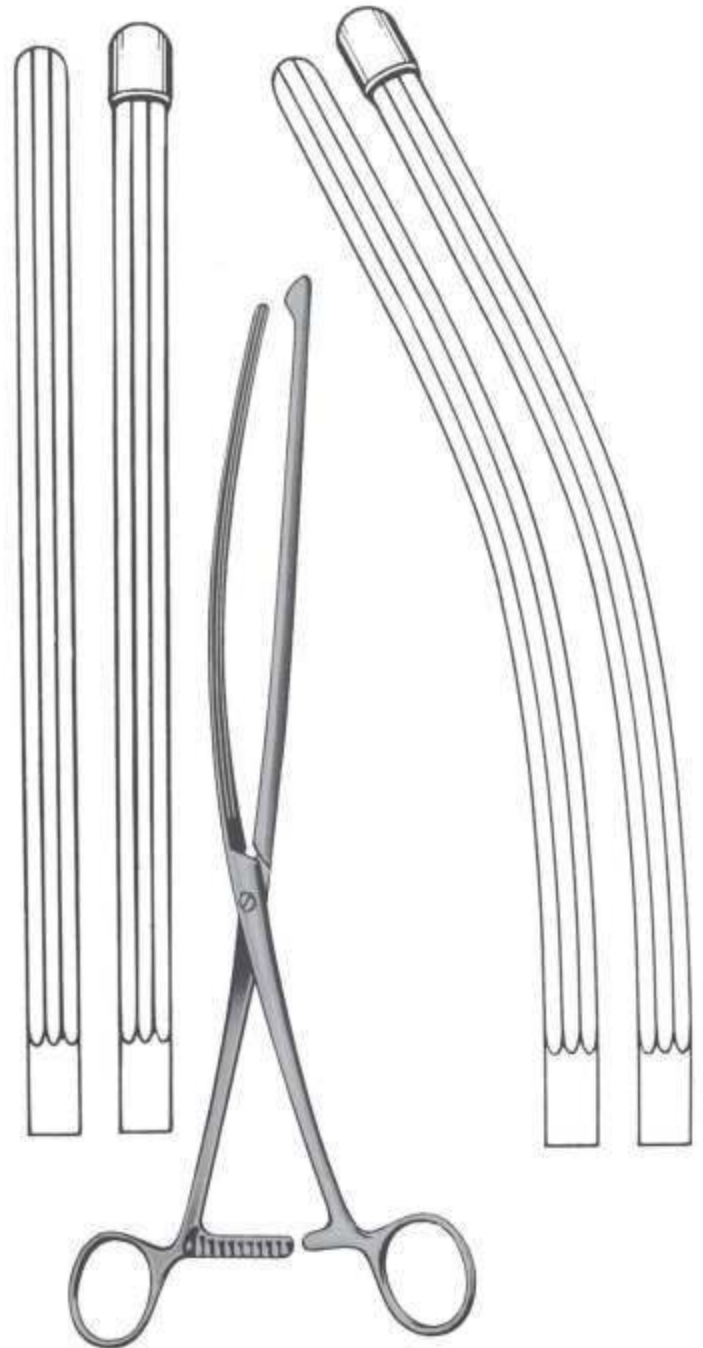

MSI-9696-30
Straight
gerade
droit
recto

Nussbaum
30 cm/12"

MSI-9697-30
Curved
Gebogene
courbe
Curvo



De Martel-Wolfson
MSI-9698-05 5cm/2"
MSI-9698-07 7cm/2¾"
MSI-9698-10 10cm/4"

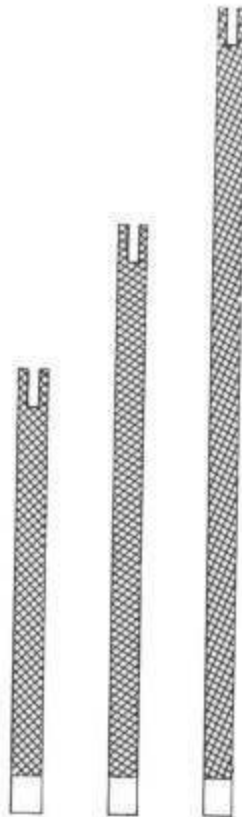

5 cm/2" 7 cm/2¾" 10 cm/4"

Set of 3 clamps
Set aus 3 Klemmen
Jeu de 3 pinces
Juego de 3 pinzas



De Martel-Wolfson
MSI-9699-00
26 cm/19¾"



MSI-9700-08
8,5 cm/½"



De Martel-Wolfson
MSI-9701-23
23 cm/9"

Stomach, Intestine and Rectum Instruments

Rectal Speculas
Rektale Speculas

Speculas rectales
especulos rectales

MEDSIGN INSTRUMENTS



Czerny
MSI-9702-22
22 cm/8¾"



Sims
MSI-9703-15



Sims
MSI-9704-15
15 cm/6"



Pratt
MSI-9705-20
80 x 25 mm
20.5 cm/8"



Mathieu
MSI-9706-19
90 x 15 mm
19.5 cm/7¾"



MSI

Length of Blades
Länge der Klängen
Longueur des lames
Duración de Blades

MSI-9707-06	60 mm
MSI-9707-08	80 mm
MSI-9707-12	125 mm
MSI-9707-15	150 mm



Barr
 MSI-9708-17
 17 cm/6¾"
 70 X 22 mm



Anal Retractors
 anal Retraktoren
 écarteurs anaux
 écarteurs anaux...

Smith-Bule
 MSI-9709-15
 15 cm/6"



Fig. 1 19 mm Ø x 70 mm
 Fig. 2 22 mm Ø x 70 mm

Bensaude
 MSI-9710-01
 MSI-9710-02



Fig. 1 16 mm Ø x 65 mm
 Fig. 2 19 mm Ø x 65 mm
 Fig. 3 22 mm Ø x 65 mm
 Fig. 4 25 mm Ø x 65 mm

Hirschmann
 MSI-9711-01
 MSI-9711-02
 MSI-9711-03
 MSI-9711-04



Kelly

Fig. 1 21 mm Ø 50 mm MSI-9712-01
 Fig. 2 27 mm Ø 50 mm MSI-9712-02



Anuscope

Ives-Fansler
 MSI-9713-22
 22 mm Ø



Proctoscopes
 Proktoskop
 Proctoscope
 proctoscopio

Fig. 1 22 mm Ø x 50 mm MSI-9714-01
 Fig. 2 22 mm Ø x 100 mm MSI-9714-02
 Fig. 3 22 mm Ø x 140 mm MSI-9714-03
 Fig. 4 22 mm Ø x 200 mm MSI-9714-04

Kelly



Park
MSI-9715-00
13 cm/5"

Consisting of:
Bestehend aus:
Composé de:
Compuesto por:

Spreader only
Spreader nur
Spreader seulement
Spreader sólo

MSI-9715-01

Pair of Blades only 95 mm
Pair of Blades nur 95 mm
Paire de lames seulement 95 mm
Par de cuchillas sólo 95 mm

MSI-9715-02



Park
MSI-9716-00
14.5 cm/5¾"

Consisting of:
Bestehend aus:
Composé de:
Compuesto por:

Spreader only
Spreader nur
Spreader seulement
Spreader sólo

MSI-9716-01

Center Blade only
Zentrum Klinge nur
Blade Center ne
Blade Center sólo

MSI-9716-02

Pair of Blades only 75 mm
Pair of Blades nur 75 mm
Paire de lames seulement 75 mm
Par de cuchillas sólo 75 mm

MSI-9716-03

Pair of Blades only 95 mm
Pair of Blades nur 95 mm
Paire de lames seulement 95 mm
Par de cuchillas sólo 95 mm

MSI-9716-04

Stomach, Intestine and Rectum Instruments

Rectal Biopsy Specimen Forceps Pince biopsie rectale
 Rektale Biopsie Zange Pinzas de biopsia rectal de muestras

MEDSIGN INSTRUMENTS



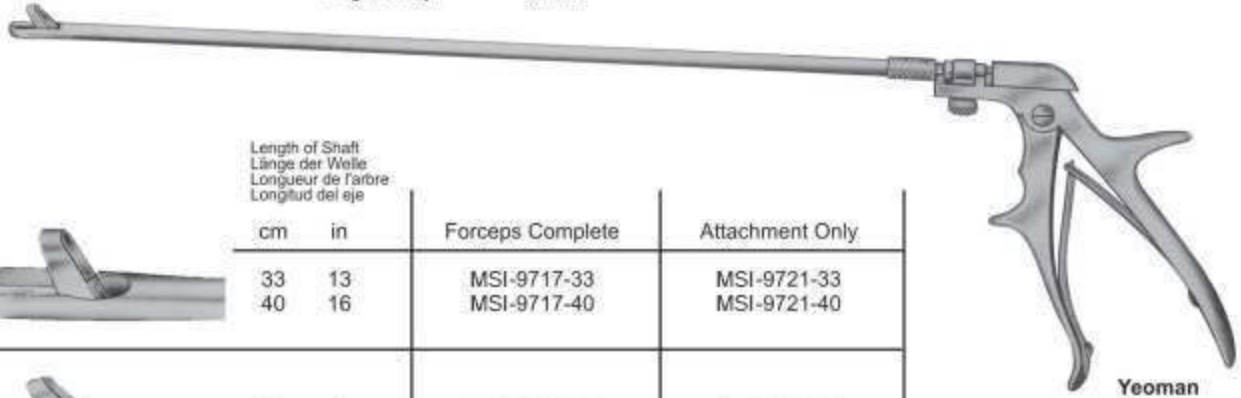

Length of Shaft
 Länge der Welle
 Longueur de l'arbre
 Longitud del eje

Turnable
 drehbare
 Tournant
 turnable



Yeoman (Turrell)
 Handle Only
 Handle nur
 Manipulez uniquement
 Manipular solo
 MSI-9721-00

Length of Shaft
 Länge der Welle
 Longueur de l'arbre
 Longitud del eje







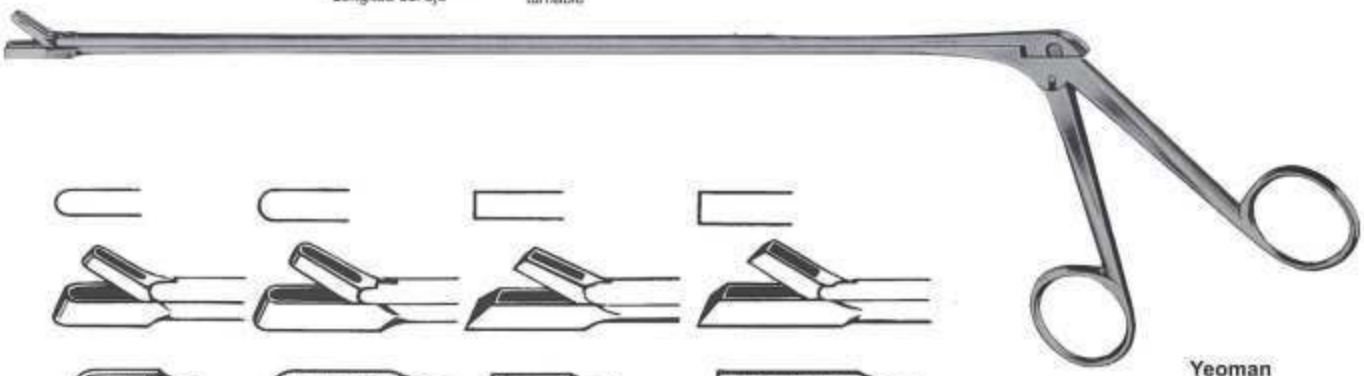



	Length of Shaft		Forceps Complete	Attachment Only
	cm	in		
	33	13	MSI-9717-33	MSI-9721-33
	40	16	MSI-9717-40	MSI-9721-40
	33	13	MSI-9718-33	MSI-9722-33
	40	16	MSI-9718-40	MSI-9722-40
	33	13	MSI-9719-33	MSI-9723-33
	40	16	MSI-9719-40	MSI-9723-40
	33	13	MSI-9720-33	MSI-9724-33
	40	16	MSI-9720-40	MSI-9724-40

Length of Shaft
 Länge der Welle
 Longueur de l'arbre
 Longitud del eje

Turnable
 drehbare
 Tournant
 turnable

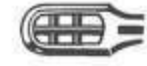
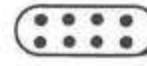

Yeoman

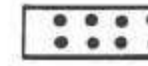
A	B	C	D
			
			
			
MSI-9725-28 MSI-9725-35 MSI-9725-42	MSI-9725-28 MSI-9725-35 MSI-9725-42	MSI-9725-28 MSI-9725-35 MSI-9725-42	MSI-9725-28 MSI-9725-35 MSI-9725-42

cm	in
28	11
35	13 ³ / ₄ "
42	16 ¹ / ₂ "

Stomach, Intestine and Rectum Instruments

Haemorrhoidal Forceps and Rectal Snares Pince Haemorrhoidal et Snares rectales
 Haemorrhoidal Pinzetten und Rectal Snares Pinzas Haemorrhoidal y trampas rectales

MEDSIGN INSTRUMENTS

Rectal Snare
 rektale Snare
 rectale piège
 rectal trampa

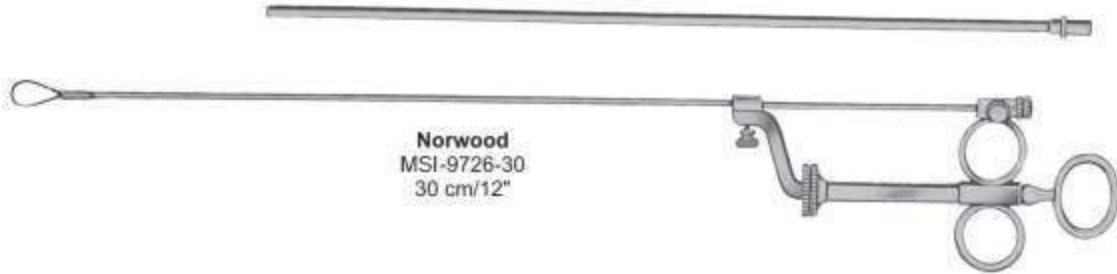

Norwood
 MSI-9726-30
 30 cm/12"

Rectal Aspiration Cannula
 Rectal Aspirationskanüle
 Canule aspiration rectale
 Cánula de aspiración recto

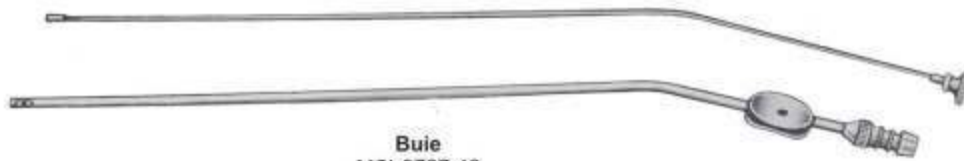

Buie
 MSI-9727-40
 Charr. 10. 40 cm/15¾"



Heywood-Smith
 MSI-9728-20
 20 cm/8"



Heywood-Smith
 MSI-9729-21
 21 cm/8¼"

Aspiration Tip

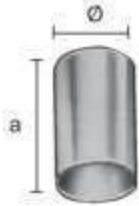

	a	Ø
MSI-9730-11	11 mm	10 mm
MSI-9730-16	16 mm	10 mm

Charging Cone



10 mm Ø

Charging Cone



12 mm Ø

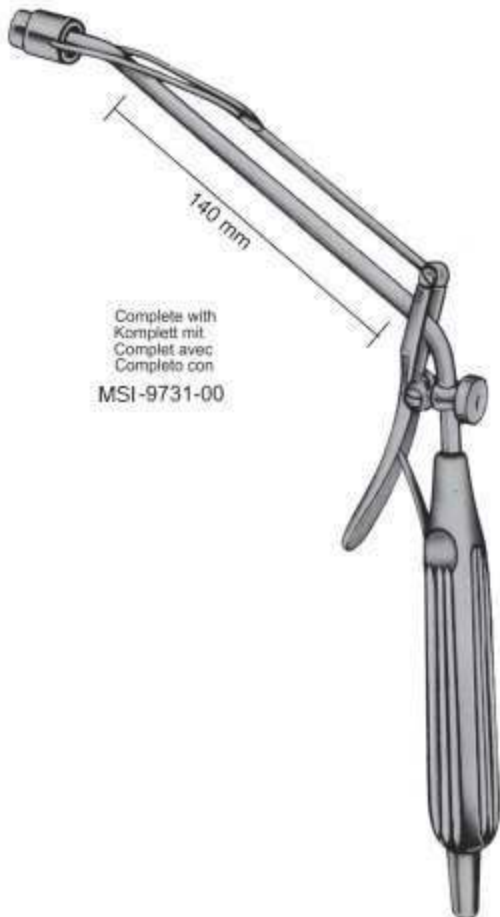

Complete with
Komplett mit
Complet avec
Completo con
MSI-9731-00

Migivney

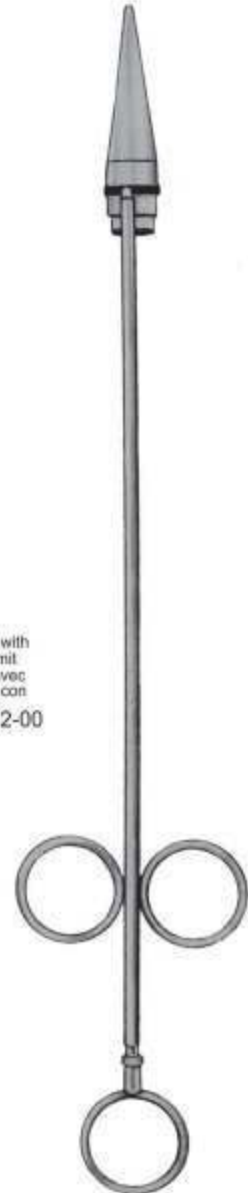

Complete with
Komplett mit
Complet avec
Completo con
MSI-9732-00

Rudd
31.5 cm/12½"



Complete with
Komplett mit
Complet avec
Completo con

MSI-9733-00

McGivney
MSI-9733-01



MSI-7573-21

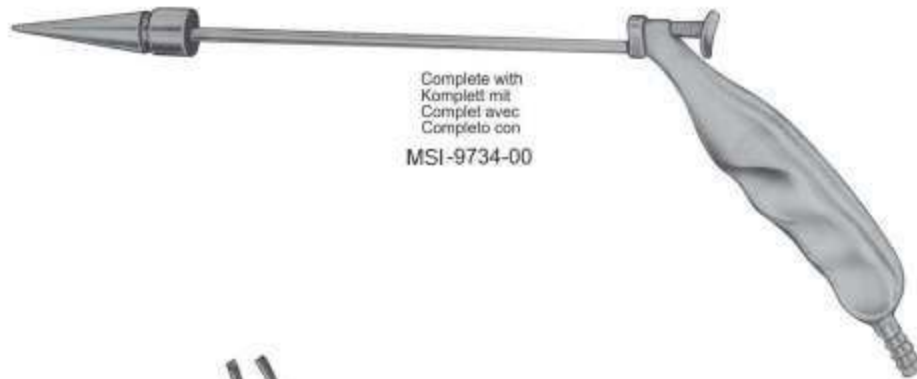

Complete with
Komplett mit
Complet avec
Completo con

MSI-9734-00

MSI-9734-01



McGivney
MSI-9735-19
19 cm / 7 1/2"