

# Bone Instruments

Bone Chisels & Gouges  
Knochenmeißeln & Gouges

Bone ciseaux et gouges  
Cinceles y Gouges



# Bone Instruments

Bone Chisels, Gouges and Osteotomes  
Knochenmeißeln, Gouges und Osteotome

Bone ciseaux, gouges et ostéotomes  
Cinceles, formones y osteotomos

MEDSIGN INSTRUMENTS



Width  
Breite  
largeur  
ancho

mm			
04	MSI-8835-04	MSI-8836-04	MSI-8837-04
06	MSI-8835-06	MSI-8836-06	MSI-8837-06
08	MSI-8835-08	MSI-8836-08	MSI-8837-08
10	MSI-8835-10	MSI-8836-10	MSI-8837-10
12	MSI-8835-12	MSI-8836-12	MSI-8837-12
14	MSI-8835-14	MSI-8836-14	MSI-8837-14
16	MSI-8835-16	MSI-8836-16	MSI-8837-16

13.5 cm/5 1/4"



mm	Partsch
02	MSI-8838-02
03	MSI-8838-03
04	MSI-8838-04
05	MSI-8838-05
06	MSI-8838-06
07	MSI-8838-07
08	MSI-8838-08

13.5 cm/5 1/4"



mm	Partsch	
02	MSI-8839-02	MSI-8840-02
03	MSI-8839-03	MSI-8840-03
04	MSI-8839-04	MSI-8840-04
05	MSI-8839-05	MSI-8840-05
06	MSI-8839-06	MSI-8840-06
07	MSI-8839-07	MSI-8840-07
08	MSI-8839-08	MSI-8840-08

17 cm/6 3/4"      13.5 cm/5 1/4"      17cm/6 3/4"



MSI-8842-04	4mm
MSI-8842-06	6mm
MSI-8842-08	8mm
MSI-8842-10	10mm
MSI-8842-12	12mm
MSI-8842-14	14mm

Poirioer  
16cm/6"



MSI-8843-02	2mm
MSI-8843-04	4mm
MSI-8843-06	6mm
MSI-8843-08	8mm
MSI-8843-10	10mm
MSI-8843-12	12mm
MSI-8843-14	14mm

Poirioer  
16cm/6"



MSI-8844-04	4mm
MSI-8844-06	6mm
MSI-8844-08	8mm
MSI-8844-10	10mm
MSI-8844-12	12mm
MSI-8844-14	14mm

Proirier Triuat  
20cm/8"

# Bone Instruments

Bone Chisels, Gouges and Osteotomes Bone ciseaux, gouges et ostéotomes  
Knochenmeißeln, Gouges und Osteotome Cinceles, formones y osteotomos



**Hautant**  
13 cm/5"

- MSI-8845-02 2 mm
- MSI-8845-04 4 mm
- MSI-8845-05 5 mm
- MSI-8845-06 6 mm
- MSI-8845-08 8 mm
- MSI-8845-10 10mm
- MSI-8845-12 12mm



**Judet**  
22 cm/8 3/4"

- MSI-8846-10 10mm
- MSI-8846-15 15mm
- MSI-8846-20 20mm
- MSI-8846-25 25mm
- MSI-8846-30 30mm
- MSI-8846-35 35mm



**Cauchoix**  
25 cm/10"

- MSI-8847-08 8 mm
- MSI-8847-10 10mm
- MSI-8847-12 12mm
- MSI-8847-14 14mm
- MSI-8847-16 16mm
- MSI-8847-18 18mm
- MSI-8847-20 20mm
- MSI-8847-25 25mm



**Cauchoix**  
25 cm/10"

- MSI-8848-16 16mm
- MSI-8848-18 18mm
- MSI-8848-20 20mm
- MSI-8849-16 16mm
- MSI-8849-18 18mm
- MSI-8849-20 20mm

# Bone Instruments

Bone Chisels, Gouges and Osteotomes    Bone ciseaux, gouges et ostéotomes  
 Knochenmeißeln, Gouges und Osteotome    Cinceles, formones y osteotomos

MEDSIGN INSTRUMENTS



**Farabeuf**  
21 cm/8 1/4"

- MSI-8850-10 10mm
- MSI-8850-15 15mm
- MSI-8850-20 20mm
- MSI-8850-25 25mm
- MSI-8850-30 30mm



**Farabeuf**  
25 cm/10"

- MSI-8851-06 6mm
- MSI-8851-08 8mm
- MSI-8851-10 10mm
- MSI-8851-12 12mm

- MSI-8851-15 15mm
- MSI-8851-20 20mm
- MSI-8851-25 25mm
- MSI-8851-30 30mm



**Maceven**  
20 cm/8"

- MSI-8852-10 10mm
- MSI-8852-15 15mm
- MSI-8852-20 20mm

# Bone Instruments

Bone Chisels, and Gouges  
Knochenmeißeln, und Gouges

Bone ciseaux, et gouges  
Cinceles, formones y



**Lexer**  
27.5 cm/10¾"

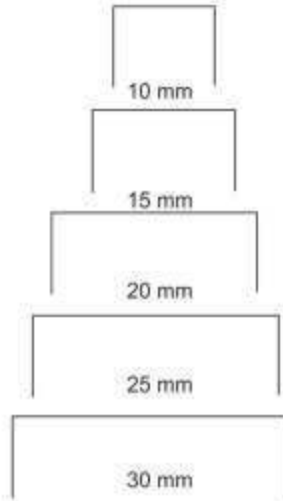

MSI-8853-10  
MSI-8853-15  
MSI-8853-20  
MSI-8853-25  
MSI-8853-30



MSI-8854-10  
MSI-8854-15  
MSI-8854-20  
MSI-8854-25  
MSI-8854-30



**Alexander**  
18 cm/7"

MSI-8855-04  
MSI-8855-06  
MSI-8855-08  
MSI-8855-10  
MSI-8855-12  
MSI-8855-14

mm  
04  
06  
08  
10  
12  
14



MSI-8856-04  
MSI-8856-06  
MSI-8856-08  
MSI-8856-10  
MSI-8856-12  
MSI-8856-14

# Bone Instruments

Bone Chisels, and Gouges · Osteotomes    Bone ciseaux, et gouges · ostéotomes  
 Knochenmeißeln, und Gouges · Osteotome    Cinceles, formones y osteotomos

MEDSIGN INSTRUMENTS



MSI-8857-02	2	MSI-8858-02
MSI-8857-03	3	MSI-8858-03
MSI-8857-04	4	MSI-8858-04
MSI-8857-05	5	MSI-8858-05
MSI-8857-06	6	MSI-8858-06
MSI-8857-07	7	MSI-8858-07
MSI-8857-08	8	MSI-8858-08



Smith-Petersen  
20 cm/8"

mm				
06	MSI-8859-06	MSI-8860-06	MSI-8861-06	MSI-8862-06
09	MSI-8859-09	MSI-8860-09	MSI-8861-09	MSI-8862-09
13	MSI-8859-13	MSI-8860-13		
14			MSI-8861-14	MSI-8862-14
16	MSI-8859-16	MSI-8860-16	MSI-8861-16	MSI-8862-16
19	MSI-8859-19	MSI-8860-19	MSI-8861-19	MSI-8862-19
25	MSI-8859-25	MSI-8860-25	MSI-8861-25	MSI-8862-25
32	MSI-8859-32	MSI-8860-32	MSI-8861-32	MSI-8862-32



# Bone Instruments

Bone Chisels, and Gouges Osteotomes Bone ciseaux, et gouges - ostéotomes  
 Knochenmeißeln, und Gouges Osteotome Circeles, formones y osteotomos

MEDSIGN INSTRUMENTS



### Lambotte mm

MSI-8863-04	04	MSI-8864-04
MSI-8863-06	06	MSI-8864-06
MSI-8863-08	08	MSI-8864-08
MSI-8863-10	10	MSI-8864-10
MSI-8863-13	13	MSI-8864-13
MSI-8863-16	16	MSI-8864-16
MSI-8863-18	18	MSI-8864-18
MSI-8863-20	20	MSI-8864-20
MSI-8863-25	25	MSI-8864-25
MSI-8863-30	30	MSI-8864-30
MSI-8863-38	38	MSI-8864-38
MSI-8863-44	44	MSI-8864-44
MSI-8863-50	50	MSI-8864-50

24 cm/9½"

23 cm/9"



### Mini-Lambotte mm

MSI-8865-02	02	MSI-8866-02
MSI-8865-03	03	MSI-8866-03
MSI-8865-04	04	MSI-8866-04
MSI-8865-06	06	MSI-8866-06
MSI-8865-08	08	MSI-8866-08
MSI-8865-10	10	MSI-8866-10
MSI-8865-12	12	MSI-8866-12
MSI-8865-15	15	MSI-8866-15

12.5 cm/5"

17 cm/6¾"



### Mini-Lexer mm

MSI-8867-04	04	MSI-8868-04
MSI-8867-06	06	MSI-8868-06
MSI-8867-08	08	MSI-8868-08
MSI-8867-10	10	MSI-8868-10
MSI-8867-12	12	MSI-8868-12

18 cm/7"



### Lexer mm

MSI-8869-05	05	MSI-8870-05
MSI-8869-07	07	MSI-8870-07
MSI-8869-10	10	MSI-8870-10
MSI-8869-15	15	MSI-8870-15
MSI-8869-20	20	MSI-8870-20
MSI-8869-25	25	MSI-8870-25
MSI-8869-30	30	MSI-8870-30

22 cm/8¾"



## Bone Instruments

Bone Chisels, and Gouges  
Knochenmeißeln, und Gouges

Bone ciseaux, et gouges  
Cinceles, formones y

MEDSIGN INSTRUMENTS



**Chisel**  
MSI-8871-20  
24.5 cm/9¾"  
20 mm



**Chisel-Curved**  
MSI-8872-20  
26.5 cm/10½"  
20 mm

Gouge for the removing of  
broken screws  
Hohlmeißel für das Entfernen von  
abgebrochener Schrauben  
Gouge pour la suppression de vis cassées  
Gubia para la remoción de tornillos rotos



MSI-8873-22  
22 cm/8¾"



# Bone Instruments

Bone Chisels, and Gouges Osteotomes Bone ciseaux, et gouges ostéotomes  
 Knochenmeißeln, und Gouges Osteotome Cinceles, formones y osteotomos



**Zielke**  
 23 cm/9"  
 5.5 mm  
 9.0 mm

MSI-8874-05  
 MSI-8874-09

Width  
 Breite  
 largeur  
 ancho



mm	MSI-8874-06	MSI-8875-06	MSI-8876-06	MSI-8877-06	MSI-8878-06
06	MSI-8874-06	MSI-8875-06	MSI-8876-06	MSI-8877-06	MSI-8878-06
08	MSI-8874-08	MSI-8875-08	MSI-8876-08	MSI-8877-08	MSI-8878-08
10	MSI-8874-10	MSI-8875-10	MSI-8876-10	MSI-8877-10	MSI-8878-10
12	MSI-8874-12	MSI-8875-12	MSI-8876-12	MSI-8877-12	MSI-8878-12
15	MSI-8874-15	MSI-8875-15	MSI-8876-15	MSI-8877-15	MSI-8878-15
20	MSI-8874-20	MSI-8875-20	MSI-8876-20	MSI-8877-20	MSI-8878-20
25	MSI-8874-25	MSI-8875-25	MSI-8876-25	MSI-8877-25	MSI-8878-25
30	MSI-8874-30	MSI-8875-30	MSI-8876-30	MSI-8877-30	MSI-8878-30

**Stille**  
 20 cm/8"



mm	MSI-8879-06	MSI-8880-06	MSI-8881-06	MSI-8882-06	MSI-8883-06
06	MSI-8879-06	MSI-8880-06	MSI-8881-06	MSI-8882-06	MSI-8883-06
09	MSI-8879-09	MSI-8880-09	MSI-8881-09	MSI-8882-09	MSI-8883-09
13	MSI-8879-13	MSI-8880-13	MSI-8881-13	MSI-8882-13	MSI-8883-13
16	MSI-8879-16	MSI-8880-16	MSI-8881-16	MSI-8882-16	MSI-8883-16
19	MSI-8879-19	MSI-8880-19	MSI-8881-19	MSI-8882-19	MSI-8883-19
25	MSI-8879-25	MSI-8880-25	MSI-8881-25	MSI-8882-25	MSI-8883-25
32	MSI-8879-32	MSI-8880-32	MSI-8881-32	MSI-8882-32	MSI-8883-32

**Hibbs**  
 24 cm/9½"

# Bone Instruments

Bone Gouges      Gouges os  
Knochen Gouges      Gouges hueso



mm      **Lexer**  
05      MSI-8884-05  
10      MSI-8884-10  
15      MSI-8884-15

28 cm/11"



**Lexer**  
MSI-8885-05  
MSI-8885-10  
MSI-8885-15

25 cm/10"



**Lexer**  
MSI-8886-05  
MSI-8886-10  
MSI-8886-15

25 cm/10"



MSI-8887-01



MSI-8887-02



MSI-8888-03

**Cobb**  
28 cm/11"



MSI-8889-04

# Bone Instruments

Bone Curettes  
Scharfe Löffel

Curettes osseuses  
Curetas óseas

Fig.000



Fig.00



Fig.0



Fig.1



Fig.2



Fig.3



Fig.4



Fig.5



Fig.6



**Bruns**  
23 cm/9"



**Bruns**  
23 cm/9"

B



C

45°



D

45°



Fig.	A	B	C	D
000	MSI-8890-30	MSI-8891-30	MSI-8892-30	MSI-8893-30
00	MSI-8890-20	MSI-8891-20	MSI-8892-20	MSI-8893-20
0	MSI-8890-10	MSI-8891-10	MSI-8892-10	MSI-8893-10
1	MSI-8890-01	MSI-8891-01	MSI-8892-01	MSI-8893-01
2	MSI-8890-02	MSI-8891-02	MSI-8892-02	MSI-8893-02
3	MSI-8890-03	MSI-8891-03	MSI-8892-03	MSI-8893-03
4	MSI-8890-04	MSI-8891-04	MSI-8892-04	MSI-8893-04
5	MSI-8890-05	MSI-8891-05	MSI-8892-05	MSI-8893-05
6	MSI-8890-06	MSI-8891-06	MSI-8892-06	MSI-8893-06

# Bone Instruments

Bone Currettes  
Scharfe Löffel

Currettes osseuses  
Curetas óseas

MEDSIGN INSTRUMENTS



**Volkmann**  
17 cm/6¾"

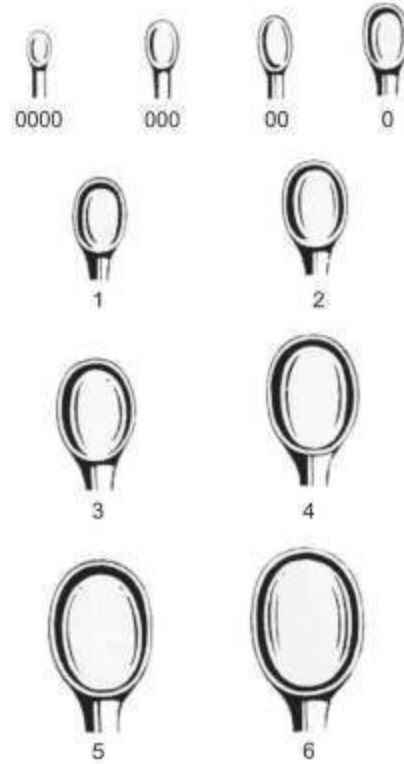

Fig.  
0000 MSI-8894-40  
000 MSI-8894-30  
00 MSI-8894-20  
0 MSI-8894-10  
1 MSI-8894-01  
2 MSI-8894-02  
3 MSI-8894-03  
4 MSI-8894-04  
5 MSI-8894-05  
6 MSI-8894-06



**Volkmann**  
17 cm/6¾"

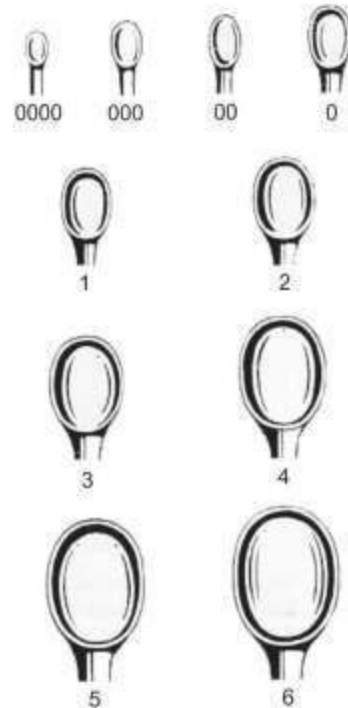

Fig.  
0000 MSI-8895-40  
000 MSI-8895-30  
00 MSI-8895-20  
0 MSI-8895-10  
1 MSI-8895-01  
2 MSI-8895-02  
3 MSI-8895-03  
4 MSI-8895-04  
5 MSI-8895-05  
6 MSI-8895-06

# Bone Instruments

Bone Curettes  
Scharfe Löffel

Curettes osseuses  
Curetas óseas



**Bruns**  
17 cm/6 3/4"

Bruns	Fig.	Spratt
MSI-8896-30	000	MSI-8897-30
MSI-8896-20	00	MSI-8897-20
MSI-8896-10	0	MSI-8897-10
MSI-8896-01	1	MSI-8897-01
MSI-8896-02	2	MSI-8897-02
MSI-8896-03	3	MSI-8897-03
MSI-8896-04	4	MSI-8897-04
MSI-8896-05	5	MSI-8897-05
MSI-8896-06	6	MSI-8897-06



**Spratt**  
16 cm/6 1/4"



Swedish pattern

mm	Round	Oval
2	MSI-8898-02	MSI-8899-03
3	MSI-8898-03	MSI-8899-04
4	MSI-8898-04	MSI-8899-05
5	MSI-8898-05	MSI-8899-06
6	MSI-8898-06	MSI-8899-07
7	MSI-8898-07	MSI-8899-08
8	MSI-8898-08	MSI-8899-10
10	MSI-8898-10	MSI-8899-12
12	MSI-8898-12	MSI-8899-14
14	MSI-8898-14	22cm/8"
	17cm/6 3/4"	1/2"



# Bone Instruments

Bone Curettes      Curettes osseuses  
Scharfe Löffel      Curetas óseas

MEDSIGN INSTRUMENTS



**Schede**  
17 cm/6¾"

Fig.	
000	MSI-8900-30
00	MSI-8900-20
0	MSI-8900-10
1	MSI-8900-01
2	MSI-8900-02
3	MSI-8900-03
4	MSI-8900-04



**Williger**  
17.5 cm/7"

Fig.	
000	Straight, Oval
0	Gerade, Oval
1	Droite, ovale
2	Oval Straight,
	MSI-8901-20
	MSI-8901-10
	MSI-8901-01
	MSI-8901-02

Fig.	
00	Straight
0	gerade
1	droit
2	recto
	MSI-8902-20
	MSI-8902-10
	MSI-8902-01
	MSI-8902-02



MSI-8903-01

**Uffendorfer**  
17 cm/6¾"



MSI-8904-02

Fig. 0  
MSI-8905-10

Fig. 1  
MSI-8905-01

Fig. 2  
MSI-8905-02

Fig. 3  
MSI-8905-03



**Volkmann**  
27 cm/10½"  
MSI-8905-00

Fig. 1  
MSI-8906-01

Fig. 2  
MSI-8906-02

Fig. 3  
MSI-8906-03



**Simon**  
24 cm/9½"  
MSI-8906-00

Fig. 4  
MSI-8906-04

Fig. 5  
MSI-8906-05

Fig. 6  
MSI-8906-06



**Simon**  
24 cm/9½"  
MSI-8907-00

Fig. 0000  
MSI-8907-40

Fig. 000  
MSI-8907-30

Fig. 00  
MSI-8907-20

Fig. 0  
MSI-8907-10

Fig.00  
MSI-8908-20

Fig.0  
MSI-8908-10

Fig. 1  
MSI-8908-01

Fig. 2  
MSI-8908-02



**Daubenspeck**  
20 cm/8"  
MSI-8908-00

# Bone Instruments

Bone Curettes  
Scharfe Löffel

Curettes osseuses  
Curetas óseas

MEDSIGN INSTRUMENTS



# Bone Instruments

Bone Currettes  
Scharfe Löffel

Currettes osseuses  
Curetas óseas



MSI-8913-21  
21 cm/8 1/4"



Epstein



Spinal



Spinal

Fig.

000  
00  
0  
1  
2  
3  
4  
5  
6

MSI-8914-30  
MSI-8914-20  
MSI-8914-10  
MSI-8914-01  
MSI-8914-02  
MSI-8914-03  
MSI-8914-04  
MSI-8914-05  
MSI-8914-06  
20 cm/8"

MSI-8915-30  
MSI-8915-20  
MSI-8915-10  
MSI-8915-01  
MSI-8915-02  
MSI-8915-03  
MSI-8915-04  
MSI-8915-05  
MSI-8915-06  
20 cm/8"

MSI-8916-30  
MSI-8916-20  
MSI-8916-10  
MSI-8916-01  
MSI-8916-02  
MSI-8916-03  
MSI-8916-04  
MSI-8916-05  
MSI-8916-06  
20 cm/8"

# Bone Instruments

Bone Curettes  
Scharfe Löffel

Curettes osseuses  
Curetas óseas

MEDSIGN INSTRUMENTS



Length	Volkmann	Volkmann
	Oval/Oval	Oval/Round
13 5"	MSI-8919-13	MSI-8920-13
14 5½"	MSI-8919-14	
16 6¼"		MSI-8920-16
17 6¾"	MSI-8919-17	
20 8"	MSI-8919-20	MSI-8920-20





## Bone Instruments

Bone Files and Rasps  
Knochen-Feilen und Raspeln

Fichiers os et râpes  
Archivos de hueso y Escofinas



Putti  
MSI-8926-30  
30 cm/12"



Putti  
MSI-8927-27  
27 cm/10½"



MSI-8928-25  
25 cm/10"



MSI-8929-24  
24 cm/9½"



MSI-8930-22  
22 cm/8¾"



# Bone Instruments

Periosteal Raspatories  
Periostale Raspatories

Périostée Couronne Instruments  
Raspatories periostio

MEDSIGN INSTRUMENTS



**Farabeuf-Collin**  
MSI-8931-15  
15.5 cm/6"  
11 mm



**Farabeuf-Collin**  
MSI-8932-15  
15.5 cm/6"  
11 mm



**Farabeuf**  
MSI-8933-15  
15 cm/6"



**Farabeuf**  
MSI-8934-15  
15 cm/6"



**Sedillot**  
MSI-8935-18  
18 cm/7"  
18 mm



**Sedillot**  
MSI-8936-21  
21 cm/8<sup>3</sup>/<sub>4</sub>"  
15 mm



**Langenbeck**  
MSI-8937-18  
18 cm/7"



**Langenbeck**  
MSI-8938-19  
19 cm/7<sup>1</sup>/<sub>2</sub>"



# Bone Instruments

Periosteal Raspatories  
 Periostale Raspatories

Périostée Couronne Instruments  
 Raspatories periostio



**Alexander**  
 MSI-8939-20  
 20 cm/8"



**Lambotte**  
 21 cm/8¼"

- |             |    |
|-------------|----|
|             | mm |
| MSI-8940-05 | 05 |
| MSI-8940-10 | 10 |
| MSI-8940-15 | 15 |
| MSI-8940-20 | 20 |
| MSI-8940-25 | 25 |



**Schneider**  
 MSI-8941-17  
 17.5 cm/7"  
 13 mm



**Schneider-Sauerbruch**  
 MSI-8942-19  
 19 cm/7½"  
 13 mm



**Jansen**  
 MSI-8943-16  
 16.5 cm/6½"  
 15 mm



**Seldin**  
 MSI-8944-19  
 19 cm/7½"



**Davidson-Alexander**  
 MSI-8945-29  
 29 cm/11½"



**Williger**  
 MSI-8946-13  
 13 cm/5"

# Bone Instruments

Periosteal Raspatories  
 Periostale Raspatories

Périostée Couronne Instruments  
 Raspatories periostio



**Williger**  
 MSI-8947-16  
 16 cm/6 1/4"



**Konig**  
 MSI-8948-15  
 15.5 cm/6"  
 5 mm



MSI-8949-06 17 cm/6 3/4"  
 6 mm

MSI-8950-08  
 8 mm



MSI-8951-01

MSI-8951-02

MSI-8951-03

MSI-8951-04

**Adson**  
 17 cm/6 3/4"

# Bone Instruments

Periosteal Raspatories  
 Periostale Raspatories

Périostée Couronne Instruments  
 Raspatories periostio



**Matson**  
 MSI-8953-22  
 22 cm/8¾"





# Bone Instruments

Periosteal Raspatories  
 Periostale Raspatories

Périostée Couronne Instruments  
 Raspatories periostio

MEDSIGN INSTRUMENTS



**Cobb**  
 24 cm/9½"



MSI-8957-04  
 4 mm



MSI-8957-06  
 6 mm



MSI-8957-08  
 8 mm



MSI-8957-10  
 10 mm



MSI-8957-13  
 13 mm



MSI-8957-19  
 19 mm



MSI-8957-25  
 25 mm

# Bone Instruments

Periosteal Raspatories  
 Periostale Raspatories

Périostée Couronne Instruments  
 Raspatories periostio



**Doyen**  
 17 cm/6¾"



MSI-8958-01



MSI-8958-02



MSI-8959-01



MSI-8959-02



MSI-8960-01



**Doyen**  
 24 cm/9½"  
 MSI-8961-01



MSI-8961-02



**Semb**



MSI-8962-01  
 19.5 cm/7½"  
 12 mm



MSI-8962-02  
 19.5 cm/7½"  
 12 mm



MSI-8962-03  
 19.5 cm/7½"  
 12 mm



MSI-8962-04  
 22 cm/8¾"  
 13 mm



MSI-8962-05  
 21.5 cm/8½"  
 13 mm



MSI-8962-06  
 22 cm/8½"  
 15 mm



MSI-8962-07  
 22 cm/8½"  
 15 mm

# Bone Instruments

Periosteal Raspatories  
 Periostale Raspatories

Périostée Couronne Instruments  
 Raspatories periostio

MEDSIGN INSTRUMENTS



MSI-8963-05  
 18.5 cm/7¼"  
 13 mm



MSI-8964-06  
 19.5 cm/7¾"  
 14 mm



MSI-8965-07  
 18.5 cm/7¼"  
 14 mm



MSI-8966-08  
 20 cm/8"  
 20 mm



MSI-8967-01  
 19 cm/7½"  
 6 mm



MSI-8968-02  
 18.5 cm/7¼"  
 3 mm



MSI-8969-03  
 18.5 cm/7¼"  
 6 mm



MSI-8970-04  
 18.5 cm/7¼"  
 6 mm

# Bone Instruments

Periosteal Raspatories  
 Periostale Raspatories

Périostée Couronne Instruments  
 Raspatories periostio



MSI-8971-20  
 27.5 cm/10¾"  
 20 mm



**Wagner**  
 8 mm MSI-8972-08 33 cm/13"  
 17 mm MSI-8972-17 33 cm/13"



**Cobb**  
 10 mm MSI-8973-10 25 cm/10"  
 13 mm MSI-8973-13 25 cm/10"  
 19 mm MSI-8973-19 25 cm/10"  
 25 mm MSI-8973-25 25 cm/10"



**Cobb**  
 10 mm MSI-8974-10 28 cm/11"  
 13 mm MSI-8974-13 28 cm/11"  
 19 mm MSI-8974-19 28 cm/11"

# Bone Instruments

Elevators  
Aufzüge

Ascenseurs  
Ascensores

MEDSIGN INSTRUMENTS



**Langenbeck**  
MSI-8975-20  
20 cm/8"  
8 mm



**Langenbeck**  
MSI-8976-20  
20 cm/8"  
10 mm



MSI-8977-07  
16 cm/6¼"  
7 mm

MSI-8977-15  
18.5 cm/7¼"  
15 mm

MSI-8977-20  
19 cm/7½"  
20 mm



**Yankauer**  
MSI-8978-18  
18 cm/7"



**Langenbeck**  
MSI-8979-23  
23 cm/9"  
11 mm



**Williger**  
MSI-8980-16  
16 cm/6¼"



**Williger**  
MSI-8981-17  
17 cm/6¾"



**Quervain**  
MSI-8982-20  
20 cm/8"

# Bone Instruments

Elevators  
Aufzüge

Ascenseurs  
Ascensores



**König**  
MSI-8983-15  
15 cm/6"  
4.5 mm



**König**  
MSI-8984-15  
15 cm/6"  
4.5 mm



**Hohman-Willinger**  
MSI-8985-16  
16 cm/6¼"



6 mm



12 mm

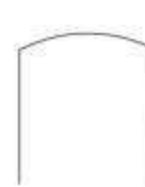

19 mm



25 mm

**Key**

6 mm	MSI-8986-06	19 cm/7 ½"
12 mm	MSI-8986-12	19 cm/7 ½"
19 mm	MSI-8986-19	19 cm/7 ½"
25 mm	MSI-8986-25	19 cm/7 ½"



**Alderdyce**  
MSI-8987-21  
21 cm/8¼"



**McDonald**  
MSI-8988-19  
19 cm/7 ½"



**Watson-Cheyne**  
MSI-8989-19  
17.5 cm/7"



**Sebilleau**  
MSI-8990-17  
17 cm/6¾"



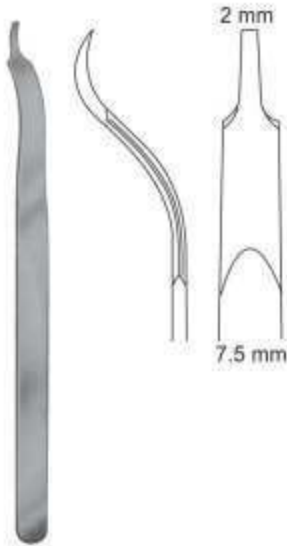

**Buck-Gramcko**  
MSI-8991-15  
15 cm/6"



**Hohmann mini**  
MSI-8992-14  
14 cm/5 1/2"  
2.8 mm



**MSI-8993-15**  
15 cm/6"  
5 mm



**MSI-8994-15**  
15 cm/6"  
7 mm



**MSI-8995-12**  
12.5 cm/5"



**Mini-Hohmann** MSI-8996-06  
16 cm/6 1/4" 6 mm



**MSI-8996-08**  
8 mm

# Bone Instruments

Bone Levers  
Knochen-Hebel

Leviers os  
Las palancas de hueso



MSI-8997-26  
26.5 cm/10 1/2"  
24 mm



Lange-Hohmann  
MSI-8998-26  
26 cm/10 1/4"  
22 mm



Hohmann  
MSI-8999-22  
22 cm/8 3/4"  
8 mm



Hohmann  
24 cm/9 1/2"

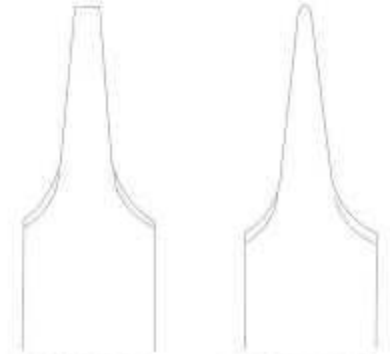

MSI-9000-17 17 mm    MSI-9001-17 17 mm  
MSI-9000-18 18 mm



**Hohmann**  
MSI-9002-26  
26 cm/10¼"  
22 mm

**Hohmann**  
MSI-9003-28  
28 cm/11"  
33 mm

**Hohmann**  
MSI-9004-24  
24 cm/9½"  
43 mm

**Hohmann**  
MSI-9005-24  
24.5 cm/9¾"  
43 mm

**Hohmann**  
MSI-9006-24  
24 cm/9½"  
70 mm

**Hohmann**  
MSI-9007-22  
22 cm/8¾"  
18 mm

# Bone Instruments

Bone Levers  
Knochen-Hebel

Leviers os  
Las palancas de hueso



**Lange-Hohmann modif**

30 mm MSI-9008-26 26.5 cm/10½"  
33 mm MSI-9008-29 29.0 cm/11½"



24 mm

**Hohmann-Aldinger**

MSI-9009-27  
27 cm/10½"

18 mm



37 mm

**Schumacher  
(Wagner)**  
MSI-9010-34  
34.5 cm/13½"

18 mm



35 mm

**Schumacher**  
MSI-9011-29  
29 cm/11½"

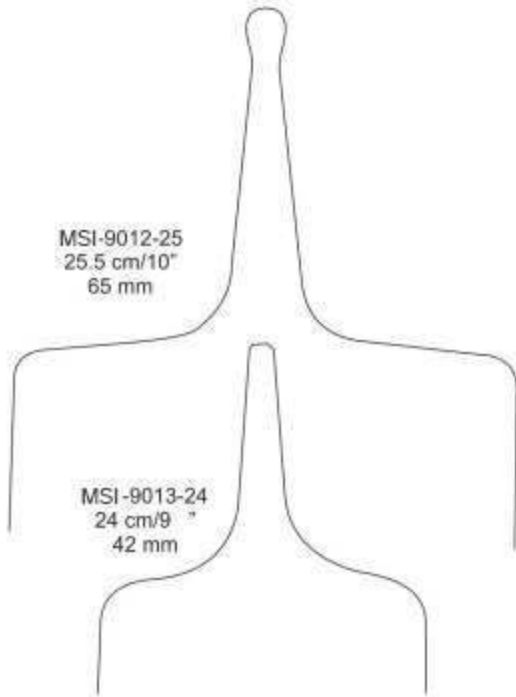

MSI-9012-25  
25.5 cm/10"  
65 mm

MSI-9013-24  
24 cm/9"  
42 mm



Verbrugge-Muller



Lane Trethowan  
MSI-9017-21  
21.5 cm/8½"



Lane  
MSI-9015-25  
25.5 cm/10"



Bristow  
MSI-9016-23  
23 cm/9"

# Bone Instruments

Bone Levers  
Knochen-Hebel

Leviers os  
Las palancas de hueso



**Blount**  
MSI-9018-26  
26 cm/10¼"



**Blount**  
MSI-9019-26  
26 cm/10¼"



**Bennett** MSI-9020-43 43 mm  
24 cm/9½" MSI-9020-60 60 mm



**Murphy-Lane**  
MSI-9021-32  
32 cm/12½"



**Chandler**

Length Länge longueur longitud	Width Breite largeur ancho	
18 cm	13 mm	MSI-9022-13
20 cm	19 mm	MSI-9022-19
23 cm	25 mm	MSI-9022-23
25 cm	30 mm	MSI-9022-30



# Bone Instruments

Meniscus and Spinal Retractors   Rétracteurs méniscales et de la moelle  
 Meniskus-und Spinal Retraktoren   Los retractoros de menisco y la columna vertebral

MEDSIGN INSTRUMENTS



**Smillie**  
14 cm/5½"

MSI-9023-01  
32x19 mm

MSI-9023-02  
48x19 mm

MSI-9023-03  
57x19 mm



MSI-9023-04  
52x13 mm



MSI-9023-05  
12x13 mm

Spinal retractors  
 Spinal Retraktoren  
 écarteurs rachidiens  
 retractoros de la columna vertebral



MSI-9024-01  
75x30 mm

MSI-9024-02  
100x30 mm

**Taylor**  
17 cm/6½"

Meniscus retractors  
 Meniskus Retraktoren  
 rétracteurs de ménisque  
 retractoros de menisco



MSI-9025-21  
21.5 cm/8½"



**Blount**  
MSI-9026-17  
17.5 cm/7"

# Bone Instruments

Meniscotomy Knives  
Meniscotomy Messer

Couteaux Meniscotomy  
Cuchillos Meniscotomy



**Smillie**  
MSI-9027-17  
17 cm/6¾"



**Smillie**  
MSI-9028-17  
17 cm/6¾"



**Smillie**  
MSI-9029-17  
17 cm/6¾"



**Salenius**  
MSI-9030-22  
22 cm/8¾"



**Salenius**  
MSI-9031-22  
22 cm/8¾"



**Neff**  
21.5 cm/8½" MSI-9033-21



**Canad-Modell**  
MSI-9034-01 20 cm/8"



MSI-9034-02



MSI-9032-17  
17.5 cm/7"



**Bircher**  
MSI-9035-20  
20.5 cm/8"

# Bone Instruments

Bone Holding Forceps  
Knochenhaltezangen

Os Davier  
Bone Pinzas

MEDSIGN INSTRUMENTS



**Dingmann Modif**  
MSI-9036-19  
19 cm/7 1/2"



**Dingmann**  
MSI-9037-19  
19cm/7 1/2"



**Neff**  
MSI-9038-21  
21cm/8 1/4"



**MSI-9039-20**  
20 cm/8"  
Straight  
gerade  
droit  
recto



**MSI-9040-20**  
20 cm/8"  
Curved on Fallt  
Gebogene am Fallt  
Courbé sur Fallt  
Curva de Fallt



**Van Buren**  
MSI-9041-23  
23 cm/9"

# Bone Instruments

Bone Holding Forceps  
Knochenhaltezangen

Os Davier  
Bone Pinzas

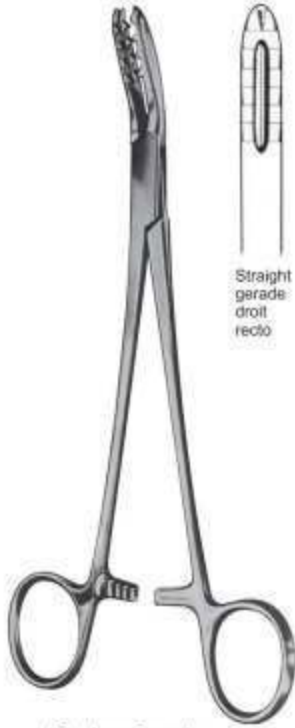

Straight  
gerade  
droit  
recto

**Bircher-Ganske**  
MSI-9042-20  
20 cm/8"



**Bircher-Ganske**  
MSI-9043-20  
20 cm/8"



**Martin**  
MSI-9044-19  
19 cm/7½"



**Lewin**  
MSI-9045-17  
17.5 cm/7"



**Fergusson**  
MSI-9046-21  
21 cm/8¼"



**Langenbeck**  
MSI-9047-21  
21 cm/8¼"

# Bone Instruments

Bone Holding Forceps  
Knochenhaltezzangen

Os Davier  
Bone Pinzas



Without Ratchet  
ohne Ratchet  
sans cliquet  
Sin Ratchet

MSI-9048-17  
MSI-9048-21

**Kern**

cm	in
17	6¾"
21	8¼"

With Ratchet  
mit Ratchet  
avec Ratchet  
Con Ratchet

MSI-9049-17  
MSI-9049-21



MSI-9050-16  
16 cm/6¼"  
MSI-9050-24  
24 cm/9½"



**Ulrich**

MSI-9051-18  
MSI-9051-23  
MSI-9051-25  
MSI-9051-28

18 cm/7"  
23 cm/9"  
25 cm/10"  
28 cm/11"



**Ulrich**

MSI-9052-18  
MSI-9052-23  
MSI-9052-25  
MSI-9052-28



**Hey Groves**

MSI-9053-21 20 cm/8"  
MSI-9053-27 25 cm/10"  
MSI-9053-30 30 cm/12"



# Bone Instruments

Bone Holding Forceps  
Knochenhaltezangen

Os Davier  
Bone Pinzas



**Semb**  
MSI-9054-19  
19 cm/7½"



**Semb**  
MSI-9055-19  
19 cm/7½"



**Verbrugge**  
MSI-9056-17  
17.5 cm/7"



**Verbrugge**

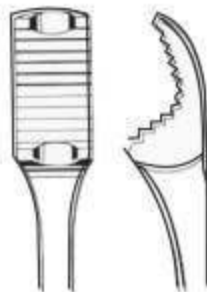

MSI-9057-25  
25 cm/10"

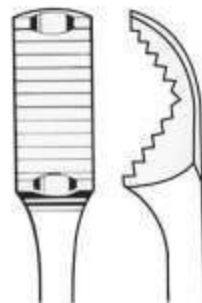

MSI-9058-26  
26 cm/10¼"  
**Verbrugge**



MSI-9059-27  
27 cm/10½"





**Self Centring**  
MSI-9060-15 15 cm/6"  
MSI-9060-19 19 cm/7 1/2"  
MSI-9060-24 24 cm/9 1/2"  
MSI-9060-26 26 cm/10 1/4"  
MSI-9060-28 28 cm/11"



Handles Detachable  
Griffe Abnehmbare  
poignées détachables  
Maneja desmontable

**Percy**  
MSI-9061-30



Adjustable  
einstellbar  
réglable  
ajustable

**Lambotte**  
MSI-9062-22 22 cm/8 3/4"  
MSI-9062-27 27 cm/10 1/2"  
MSI-9062-30 30 cm/12"



**Farabeuf**  
MSI-9063-23 23 cm/9"  
MSI-9063-26 26 cm/10 1/4"



**Lambotte**  
MSI-9064-22 22.5 cm/9"  
MSI-9064-25 25.5 cm/10 1/2"  
MSI-9064-33 33 cm/13 1/2"

## Bone Instruments

Bone Holding Forceps  
Knochenhaltezangen

Os Davier  
Bone Pinzas



**Farabeuf-Lambotte**  
MSI-9065-26  
26 cm/10¼"



**Lambotte**  
MSI-9066-19 19 cm/7½"  
MSI-9066-23 23 cm/9"  
MSI-9066-26 26 cm/10¼"



	<b>Lane</b>	
	cm in	
MSI-9067-33	33 13"	MSI-9068-33
MSI-9067-45	45 17¾"	MSI-9068-45
	Without Ratchet ohne Ratchet sans cliquet Sin Ratchet	With Ratchet mit Ratchet avec Ratchet Con Ratchet



MSI-9069-14  
14.5 cm/5¾"



MSI-9070-12  
12 cm/4¾"



MSI-9071-13  
13.5 cm/5¼"

# Bone Instruments

Bone Holding Forceps and Bone Holding Clamps    Os Davier et os Pincas de portefeuille  
 Knochenhaltezange and Bone Halteklammer    Hueso y huesos Pinzas abrazaderas que sujetan

MEDSIGN INSTRUMENTS



MSI-9072-20  
20 cm/8"



MSI-9073-17  
17 cm/6¾"



MSI-9074-17  
17.5 cm/7"

Traction Bar  
Traktion Bar  
barre de traction  
tracción Bar



Lowman-Hoglund  
MSI-9075-19  
19 cm/7½"



Lowman  
MSI-9076-18 18 cm/7"  
MSI-9076-20 20 cm/8"  
MSI-9076-22 22 cm/8¾"



Lowman  
MSI-9077-12  
12 cm/4¾"

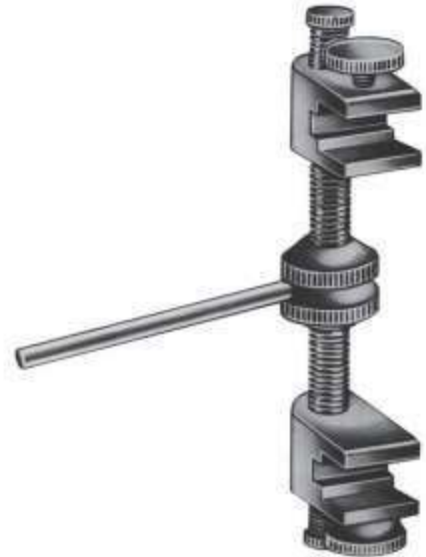

Gerster  
MSI-9078-18  
MSI-9078-50

## Bone Instruments

Bone Rongeur Forceps  
Knochen Hohlmeißelzange

Os Rongeur Forceps  
Pinzas gubia ósea



**Clovis Vincent**  
MSI-9079-21 21 cm/8¼"  
MSI-9079-26 26 cm/10¼"



**Bane-Hartmann**  
MSI-9080-17  
17.5 cm/7"



**Mini-Friedmann**  
MSI-9081-12  
12.5 cm/5"



**Friedmann**  
MSI-9082-14  
14 cm/5½"

# Bone Instruments

Bone Rongeur Forceps  
Knochen Hohlmeißelzange

Os Rongeur Forceps  
Pinzas gubia ósea



**Friedmann-Delicate**  
15 cm/6"



MSI-9083-15



90°

MSI-9083-90



**Bacon**  
MSI-9084-20  
20 cm/8"



**Hartmann**  
MSI-9085-18  
18.5 cm/7¼"



**Cleveland**  
MSI-9086-14 14 cm/5½"  
MSI-9086-17 17 cm/6¾"



**Olivecrona**  
MSI-9087-20  
20 cm/8"



# Bone Instruments

Bone Rongeur Forceps  
Knochen Hohlmeißelzange

Os Rongeur Forceps  
Pinzas gubia ósea



**Lempert**

MSI-9088-16	cm	in	MSI-9089-16
MSI-9088-19	16	6 1/4"	MSI-9089-19
	19	7 1/2"	
Straight			Curved
gerade			Gebogene
droit			courbé
recto			Curvo



**Beyer**  
MSI-9090-18  
18 cm/7"



**Mead**  
16.5 cm/6 1/2"



MSI-9091-16



MSI-9092-16



**Blumenthal**  
15.5 cm/6"



MSI-9093-15



MSI-9094-15



MSI-9095-15



**Hakansson**  
MSI-9096-15  
15.5 cm/6"



**Jansen**  
18 cm/7"



MSI-9097-17



MSI-9098-17



# Bone Instruments

Bone Rongeur Forceps  
Knochen Hohlmeißelzange

Os Rongeur Forceps  
Pinzas gubia ósea



MSI-9099-22

Straight  
gerade  
droit  
recto



MSI-9100-22

Curved  
Gebogene  
courbé  
Curvo

**Stille-Luer**  
22 cm/8¾"



MSI-9101-27



MSI-9102-27

**Stille-Luer**  
27 cm/10½"



**Semb**  
MSI-9103-23  
23 cm/9"

# Bone Instruments

Bone Rongeur Forceps  
Knochen Hohlmeißelzange

Os Rongeur Forceps  
Pinzas gubia ósea



**Jansen**  
MSI-9104-18  
18 cm/7"



**MSI-9105-17**  
Straight  
gerade  
droit  
recto

**MSI-9106-17**  
Curved  
Gebogene  
courbé  
Curvo

**Luer**  
17 cm/6¾"



Heavy Pattern  
schwere Pattern  
modèle lourd  
patrón pesado

**Luer**  
18.5 cm/7¼"  
MSI-9107-15



**Luer**  
15 cm/6"

MSI-9108-15

MSI-9109-15

MSI-9110-15



**Adson**  
20 cm/8"

MSI-9111-20

# Bone Instruments

Bone Rongeur Forceps  
Knochen Hohlmeißelzange

Os Rongeur Forceps  
Pinzas gubia ósea



**Bohler**  
15cm/6"

Straight  
gerade  
droit  
recto



MSI-9112-15



MSI-9113-15



**Kleinert-Kutz**  
15cm/6"



MSI-9114-15  
2mm



MSI-9115-15  
3mm



**Beyer  
Zaufal-Jansen**  
18 cm/7"



**Zaufal-Jansen**  
MSI-9116-18

Straight  
gerade  
droit  
recto



**Beyer**  
MSI-9117-18



**Mayfield**  
MSI-9118-17  
17 cm/6 3/4"



**Ruskin**  
MSI-9119-18  
18 cm/7"

Straight  
gerade  
droit  
recto

MSI-9120-18  
18 cm/7"  
MSI-9120-23  
23 cm/9"



**Ruskin**



Straight  
gerade  
droit  
recto

MSI-9121-18  
18 cm/7"  
MSI-9121-23  
23 cm/9"

# Bone Instruments

Bone Rongeur Forceps  
Knochen Hohlmeißelzange

Os Rongeur Forceps  
Pinzas gubia ósea



**Marquardt**  
MSI-9122-20  
20 cm/8"



**Rottgen-Ruskin**  
MSI-9123-24  
24 cm/9½"



**Smith-Petersen**  
24 cm/9½"



MSI-9124-03  
3 mm



MSI-9124-04  
4 mm



MSI-9124-05  
5 mm



MSI-9125-03  
3 mm



MSI-9125-04  
4 mm



MSI-9125-05  
5 mm



# Bone Instruments

Bone Rongeur Forceps  
Knochen Hohlmeißelzange

Os Rongeur Forceps  
Pinzas gubia ósea



**Stille-Ruskin**  
MSI-9126-23  
23 cm/9"



**Echlin**  
23 cm/9"

MSI-9127-02  
2 mm

MSI-9127-03  
3 mm

MSI-9127-04  
4 mm



**Leksell**  
23 cm/9"

MSI-9128-03  
3 mm

MSI-9128-04  
4 mm

MSI-9128-06  
6 mm

MSI-9128-08  
8 mm



**Frykholm**  
MSI-9129-23  
23 cm/9"



**Stille**  
MSI-9130-23  
23 cm/9"



**Sauerbruch**  
30 cm/12"

MSI-9131-30

MSI-9132-30



# Bone Instruments

Bone Cutting Forceps  
Knochensplitterzangen

Pince de coupe d'os  
Pince de coupe d'os...



**Markwalder**  
MSI-9133-20  
20 cm/8"



MSI-9134-14	14	5 1/2"
MSI-9134-17	17	6 3/4"
MSI-9134-19	19	7 1/2"
MSI-9134-22	22	8 3/4"

Straight  
gerade  
droit  
recto



MSI-9135-14	14	5 1/2"
MSI-9135-17	17	6 3/4"
MSI-9135-19	19	7 1/2"
MSI-9135-22	22	8 3/4"

Curved  
Gebogene  
courbé  
Curvo



**Littauer-Liston**  
MSI-9136-15  
15 cm/6"



**Cleveland**  
MSI-9137-15 15 cm/6"  
MSI-9137-17 17 cm/6 3/4"



**Bohler**  
15 cm/6"

MSI-9138-15  
Straight  
gerade  
droit  
recto

MSI-9139-15  
Curved on flat  
Gebogene auf flachen  
Courbé sur le plat  
Curva plana en



**McIndoe**  
MSI-9140-17  
17.5 cm/7"

# Bone Instruments

Bone Cutting Forceps  
Knochensplitterzangen

Pince de coupe d'os  
Pince de coupe d'os...



**Liston-Key (Horsley)**  
MSI-9141-27  
27 cm/10½"



**Semb**  
MSI-9142-27-24  
24 cm/9½"



**Kazanjian**  
U12-9143-27-18  
18 cm/7"



**Ruskin-Liston**  
18.5 cm/7¼"

MSI-9144-18  
Straight  
gerade  
droit  
recto



MSI-9145-18  
Curved on flat  
Gebogene auf flachen  
Courbé sur le plat  
Curva plana en



**Stille-Liston**  
23 cm/9"  
27 cm/10½"

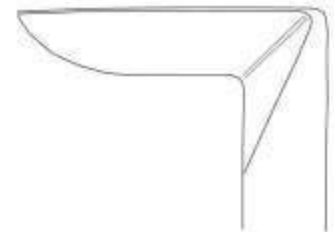

MSI-9147A-27  
27 cm/10½"

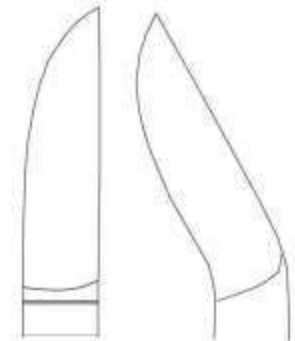

MSI-9146-23  
MSI-9146-27

MSI-9147-23  
MSI-9147-27

# Bone Instruments

Nail Instruments and Finger Ring Cutters Nail Instruments et couteaux pour bagues  
 Nail Instruments und Fingerring Schneider Instrumentos y cortadores de uñas del dedo del anillo



MSI-9148-13  
13.5 cm/5"



18 cm/7"



MSI-9149-18



MSI-9150-18



**Radolf**  
MSI-9151-13  
13.5 cm/5¼"



Saw blade  
Sägeblatt  
lame de scie  
hoja de sierra

MSI-9152-17  
17 cm/6¾"



Saw blade  
Sägeblatt  
lame de scie  
hoja de sierra

**Walton**  
MSI-9153-17  
17 cm/6¾"

# Bone Instruments

Amputation and Resection Saws  
Amputation und Resektion Sägen

Scies d'amputation et résection  
Amputación y resección Sierras

MEDSIGN INSTRUMENTS



**Langenbeck**  
MSI-9154-23  
23 cm/9"



**Satterlee**  
MSI-9155-31  
31 cm/12 1/4"



**Charriere**  
MSI-9156-27 27 cm/10 1/2"  
MSI-9156-30 30 cm/12"  
MSI-9156-34 34 cm/13 1/2"

Spare saw blades  
Spare Sägeblättern  
Lames de scie de rechange  
Cuchillas de recambio sierra

MSI-9157-43 3 mm  
MSI-9157-45 5 mm  
MSI-9157-47 7 mm

Complete with 3 blades  
Komplett mit 3 Klingen  
Livré avec 3 lames  
Completo con 3 cuchillas  
MSI-9157-39



**Helferich-Bier**

Spare saw blades  
Spare Sägeblättern  
Lames de scie de rechange  
Cuchillas de recambio sierra

MSI-9158-12 12 mm  
MSI-9158-15 15 mm

Complete with 2 blades  
Komplett mit 2 Klingen  
Livré avec 2 lames  
Completo con 2 cuchillas  
MSI-9158-35



**Charriere**

## Bone Instruments

Bone Drills  
Bone Drills

Perceuses os  
Bone Drills

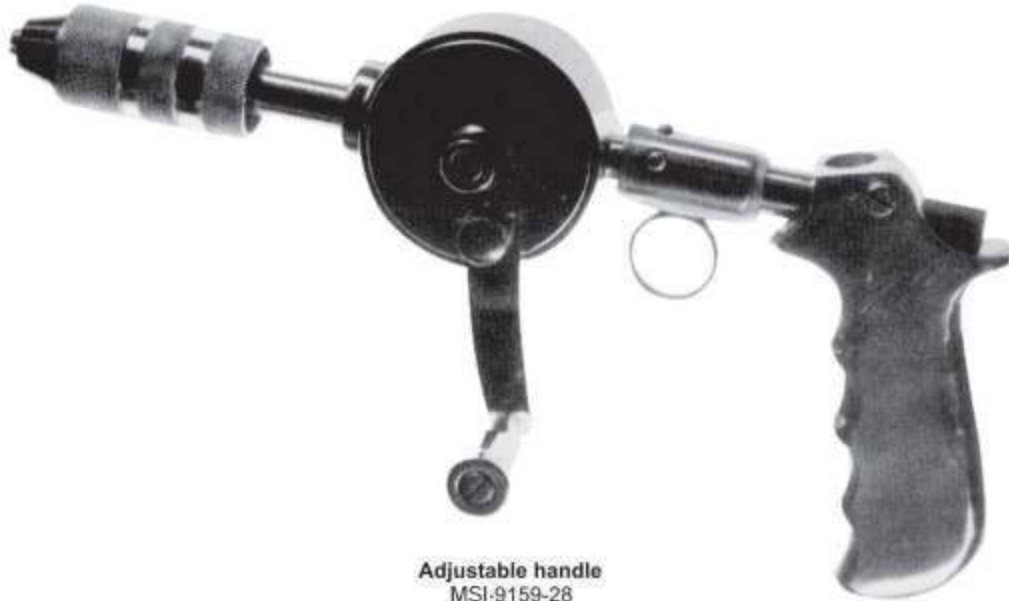

**Adjustable handle**  
MSI-9159-28  
28cm/11"



MSI-9160-11  
Key only  
Key nur  
seule clé  
clave única



**Ralk**  
MSI-9161-00  
accomodating up to 6.35mm Ø



# Bone Instruments

Bone Drills  
Bone Drills

Perceuses os  
Bone Drills

MEDSIGN INSTRUMENTS



**Stille**  
MSI-9162-00



Fig. 1  
MSI-9162-01  
Ø2,5mm



Fig. 2  
MSI-9162-02  
3,0mm



Fig. 3  
MSI-9162-03  
3,5mm



Fig. 4  
MSI-9162-04  
4,0mm



Fig. 5  
MSI-9162-05  
10,0mm



Fig. 6  
MSI-9162-06  
5,0mm



Fig. 7  
MSI-9162-07  
Ø8,0mm



Fig. 8  
MSI-9162-08  
12,0mm



Fig. 9  
MSI-9162-09  
16,0mm



**Hudson**  
MSI-9163-00  
27cm/10½"

MSI



Fig. 1  
MSI-9163-01  
Ø9 mm



Fig. 2  
MSI-9163-02  
14mm



Fig. 3  
MSI-9163-03  
16mm



Fig. 4  
MSI-9163-04  
22mm



**Cushing**  
MSI-9163-05  
Ø14mm



**Mckenzie**  
MSI-9163-09  
Ø13mm



MSI-9163-00

## Bone Instruments

Drill Guide and Dura Protecting Forceps  
Bohrerführung und Dura Schutz Zange

Guide-mèche et Pince Dura Protection  
Guía de broca y pinzas Dura Protección



**Adson**  
MSI-9164-15  
15 cm/6"

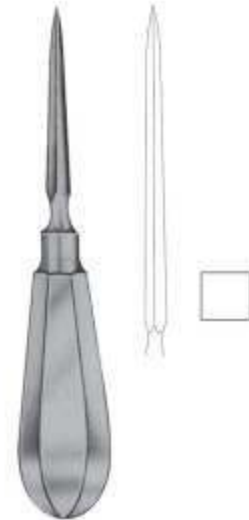

MSI-9165-14  
14 cm/5½"



MSI-9166-14  
14 cm/5½"



**Perthes**  
MSI-9167-21  
21 cm/8¼"

# Bone Instruments

Wire Seizing Forceps  
Draht Zange ergreifen

Pince fil Saisir  
Pinzas de alambre Aprovechar

MEDSIGN INSTRUMENTS



MSI-9168-18 18 cm/7"  
MSI-9168-20 20 cm/8"



MSI-9169-16  
15 cm/6"

MSI-9169-20  
20 cm/8"

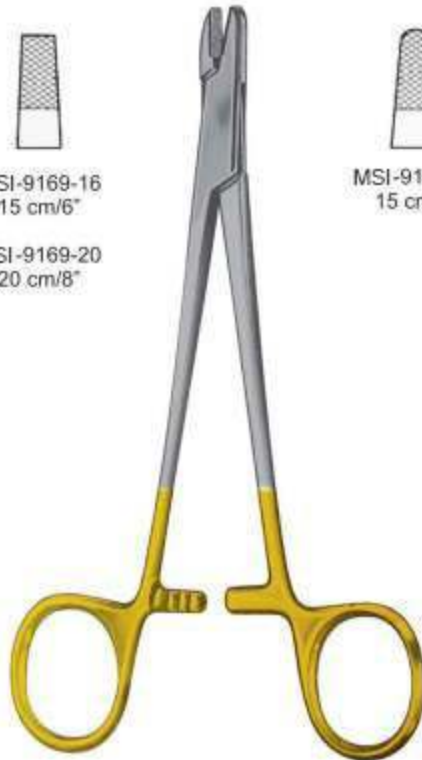

MSI-9170-16  
15 cm/6"



MSI-9171-14  
14 cm/5½"



MSI-9172-16  
16 cm/6¼"



18cm/7"



MSI-9173-01



MSI-9173-02



MSI-9173-03



MSI-9173-04



MSI-9173-05

## Bone Instruments

Wire Seizing Forceps  
Draht Zange ergreifen

Pince fil Saisir  
Pinzas de alambre Aprovechar



MSI-9174-15  
15.5 cm/6"



MSI-9175-18  
18 cm/7"



MSI-9176-13 13 cm/5"  
MSI-9176-18 18 cm/7"

# Bone Instruments

Wire Cutting Pliers  
Drahtschneidezangen

Pince coupante fil  
Alicates de corte de alambre

For soft wire  
with a diam. of max.  
For hard wire  
with a diam. of max.



MSI-9178-15  
24 cm/9 1/2"  
4.0 mm  
3.5 mm



MSI-9179-18  
18.5 cm/7 1/4"  
1.7 mm  
1.7 mm



2.0 mm  
1.5 mm  
MSI-9180-15  
15 cm/6"



2.0 mm  
2.0 mm  
MSI-9181-16  
16 cm/6 1/4"



## Bone Instruments

Wire Cutting Pliers  
Drahtschneidezangen

Pince coupante fil  
Alicates de corte de alambre



MSI-9182-12  
12 cm/4 3/4"

0.7 mm  
0.5 mm



MSI-9183-15  
15 cm/6"

2.0 mm  
1.0 mm



MSI-9184-18  
18 cm/7"

2.0 mm  
1.7 mm

# Bone Instruments

Wire Cutting Pliers  
Drahtschneidezangen

Pince coupante fil  
Alicates de corte de alambre

MEDSIGN INSTRUMENTS



MSI-9185-18  
18.5 cm/7 1/4"



MSI-9186-18 18 cm/7"  
MSI-9187-22 22 cm/8 3/4"



MSI-9188-22  
22 cm/8 3/4"



MSI-9189-47 47 cm/18 1/2"  
MSI-9189-57 57 cm/22 1/2"

# Bone Instruments

Extension Bows  
Erweiterung Bögen

Arcs d'extension  
Arcos de extensión

with 3 traction hooks  
mit 3 Traktion Haken  
avec 3 crochets de traction  
con 3 ganchos de tracción

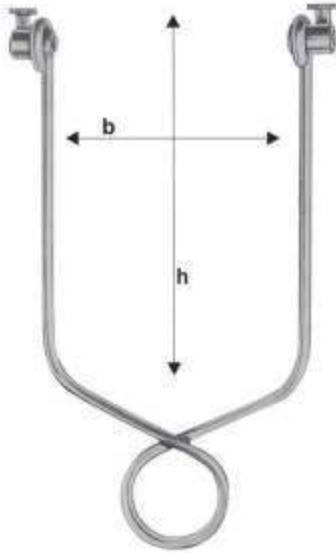

cm h x b	in h x b	
16 x 9	6 1/4 x 3 1/2	MSI-9190-16
21 X 11	8 1/4 X 4 1/2	MSI-9190-21
21 X 15	8" X 6"	MSI-9190-15



Kirschner

Clear width  
lichte Breite  
largeur libre  
anchura libre

	cm	in
MSI-9191-01	9,5x7	3 3/4 x 2 3/4
MSI-9191-02	10,5x10,5	4 1/4 x 4 1/4
MSI-9191-03	12x12	4 3/4 x 4 3/4
MSI-9191-04	15,5x15,5	6x6
MSI-9191-05	20x15,5	8x6

with 3 traction hooks  
mit 3 Traktion Haken  
avec 3 crochets de traction  
con 3 ganchos de tracción

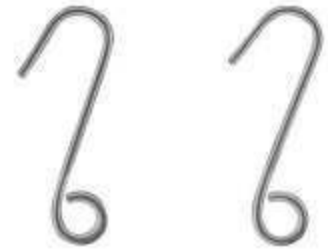

MSI-9194-40

MSI-9194-42



Kirschner

Clear width  
lichte Breite  
largeur libre  
anchura libre

	cm	in
MSI-9192-18	18x10	07x04
MSI-9192-27	27x16	10 1/2 x 6 1/4



Kirschner

MSI-9193-01 Small Pattern  
MSI-9193-02 Medium Pattern  
MSI-9193-03 Large Pattern

Wire Strainer  
Draht Strainer  
Passoire fil  
Colador de alambre



MSI-9194-20

# Bone Instruments

Bone Wire, Twisting Instruments and Guides Fil d'os, instruments de torsion et Guides  
 Knochen-Wire, Zwirn-Instrumente und Guides Alambre de hueso, instrumentos giratorios y guías

MEDSIGN INSTRUMENTS



**Loute**  
 MSI-9195-21  
 21 cm/8¼"

Bone Wire Tighteners  
 Knochen Draht Spanner  
 Tendeurs Fil os  
 Tensores de cables y Bone



**Demel**  
 MSI-9196-28  
 28 cm/11"



**Demel**

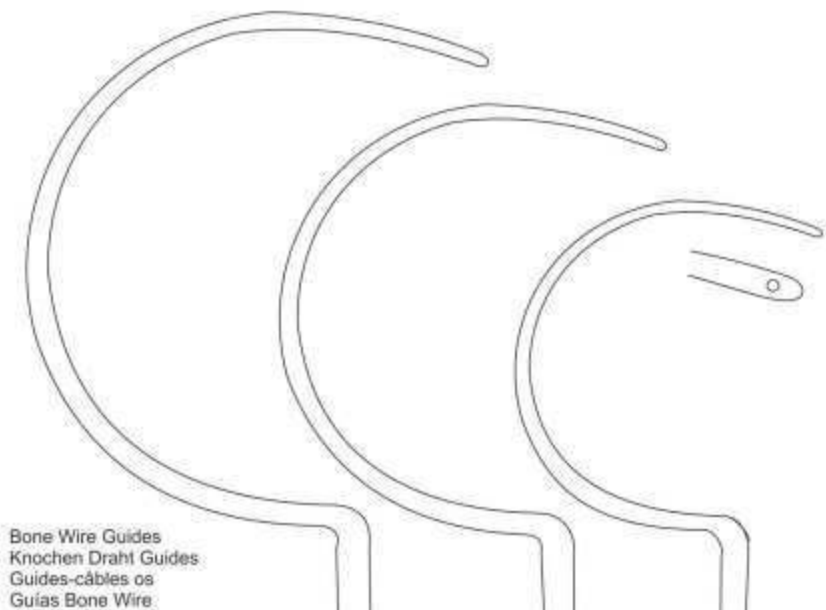

Bone Wire Guides  
 Knochen Draht Guides  
 Guides-cables os  
 Guías Bone Wire

Fig. 1 MSI-9197-01  
 Fig. 2 MSI-9197-02  
 Fig. 3 MSI-9197-03

Fig. 1

Fig. 2

Fig. 3

# Bone Instruments

Bone Nail  
Knochen Nagel

Des clous à os  
Bone uñas



length Schanz

length	Ø 5 mm
8 cm	MSI-9198-08
10 cm	
12 cm	MSI-9198-12
14 cm	
15 cm	MSI-9198-15
16 cm	
17 cm	MSI-9198-17
18 cm	
20 cm	MSI-9198-20
22 cm	
25 cm	MSI-9198-25
30 cm	

with triangular end  
mit dreieckigem Ende  
avec extrémité triangulaire  
con extremo triangular



with trocar point  
mit Trokarspitze  
avec pointe trocart  
con punto de trocart

Length  
Länge  
longueur  
longitud

Steinmann

Length Länge longueur longitud	Ø		
	4 mm	4,5 mm	5 mm
8 cm	MSI-9199-08	MSI-9200-08	MSI-9201-08
10 cm	MSI-9199-10	MSI-9200-10	MSI-9201-10
12 cm	MSI-9199-12	MSI-9200-12	MSI-9201-12
14 cm	MSI-9199-14	MSI-9200-14	MSI-9201-14
15 cm			
16 cm	MSI-9199-16	MSI-9200-16	MSI-9201-16
17 cm			
18 cm	MSI-9199-18	MSI-9200-18	MSI-9201-18
20 cm	MSI-9199-20	MSI-9200-20	MSI-9201-20
22 cm	MSI-9199-22	MSI-9200-22	MSI-9201-22
25 cm	MSI-9199-25	MSI-9200-25	MSI-9201-25
30 cm	MSI-9199-30	MSI-9200-30	MSI-9201-30





22 cm/8 1/2"

300 g MSI-9202-10  
500 g MSI-9202-35  
600 g MSI-9202-50  
940 g MSI-9202-70



with interchangeable  
mit austauschbaren  
avec interchangeables  
intercambiable con

Ø 30 mm  
215 g

MSI-9203-24  
24.5 cm/8 3/4"



Ø 30 mm  
400 g

Ø 42 mm

MSI-9204-24  
24 cm/9 1/2"



Ø 45 mm  
300 g

**Bergmann**  
MSI-9205-24  
24 cm/9 1/2"



Ø 25 mm  
140 g

MSI-9206-18  
18 cm/7"

# Bone Instruments

Mallets  
Mallets

Maillets  
mazos



150 g



**Williger**  
MSI-9207-23  
23 cm/9"



Ø 30 mm  
460 g



**Bergmann**  
MSI-9208-23  
23 cm/9"



1 Side Flat  
1 Side Convex



**Cottle**  
MSI-9209-19  
Ø 30 mm  
19 cm/7 1/2"  
350 g



Ø 42 mm  
400 g

Ø 42 mm  
250 g



MSI-9210-24  
24cm/9 1/2"



Ø 30 mm



**Ombredanne**  
MSI-9211-24  
23.5cm/9 1/4"



Ø 40 mm



**Heath**  
MSI-9212-18  
18 cm/7"



**Lucae**  
19 cm/7½"

Fig. 1 MSI-9213-19 19mm O 230 g  
Fig. 2 MSI-9213-25 25mm O 260 g



320 g  
Ø26 mm

**Mead**  
MSI-9214-17  
17 cm/6¾"



**Williger**  
MSI-9215-16  
16.5 cm/6½"



165 g  
Ø22 mm

MSI-9216-19  
19 cm/7½"



**Gerzog**  
MSI-9217-19  
19 cm/7½"



200 g  
22 mm Ø  
(7 oz.)

**Partsch**  
MSI-9218-18  
18 cm/7"

# Bone Instruments

Tendon Seizing Instruments  
Tendon ergriff Instruments

Tendon Instruments Saisir  
Aprovechar los instrumentos del tendón



**Fischer**  
MSI-9219-31  
31 cm/12¼"



MSI-9220-50  
50 cm/19½"  
6 mm Ø

**Brand**



MSI-9221-30  
30 cm/12"  
3 mm Ø



**Brand**  
MSI-9222-50  
50 cm/19½"

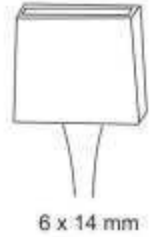

6 x 14 mm

Tendon Strippers  
Sehnen Strippers  
Décapants tendon  
Strippers tendón



mm Ø  
4.0 MSI-9223-40  
4.5 MSI-9223-45  
5.5 MSI-9223-55

Flexible Shaft  
flexible Welle  
arbre flexible  
eje flexible



**Steinmann**  
MSI-9224-50  
16 cm/6½"

# Bone Instruments

Tendon Seizing Instruments  
Tendon ergriff Instruments

Tendon Instruments Saisir  
Aprovechar los instrumentos del tendón

MEDSIGN INSTRUMENTS



**Steinmann**  
MSI-9225-13  
13 cm/5"



MSI-9226-20



MSI-9227-20

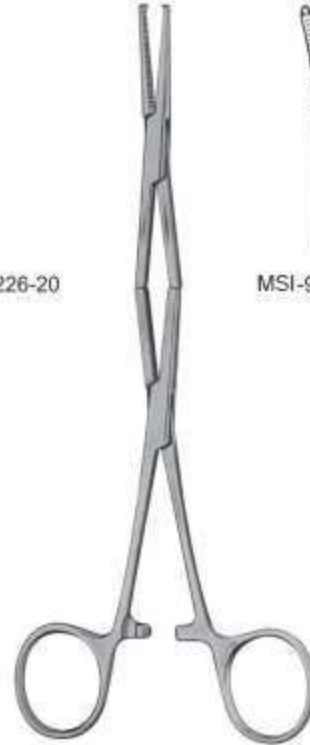

20 cm/8"



**Caroll**  
MSI-9228-11  
11 cm/4½"



MSI-9229-15  
15 cm/6"



MSI-9230-15  
15 cm/6"



# Bone Instruments

Tendon Seizing Instruments  
Tendon ergriff Instruments

Tendon Instruments Saisir  
Aprovechar los instrumentos del tendón



**Kleinert-Kutz**  
MSI-9231-20  
16 cm/8"



**Brand**  
MSI-9232-15 16 cm/6"  
MSI-9232-19 19 cm/7½"  
MSI-9232-24 24 cm/9½"



**Brand**  
MSI-9233-15 16 cm/6"  
MSI-9233-19 19 cm/7½"  
MSI-9233-24 24 cm/9½"